

BUILDING
COMMON GROUND



Sealing technologies

Waterproofing system solutions





BUILDING
COMMON GROUND



Sealing technologies

Applications	4
Product overview	5
Explanations	6
Zemseal® sub-structure waterproofing system	11
Fradiflex® metal waterstop	17
Intec® injection hose system	27
Cresco® expanding waterstop	33
Product combinations	36
References	37
Information	38

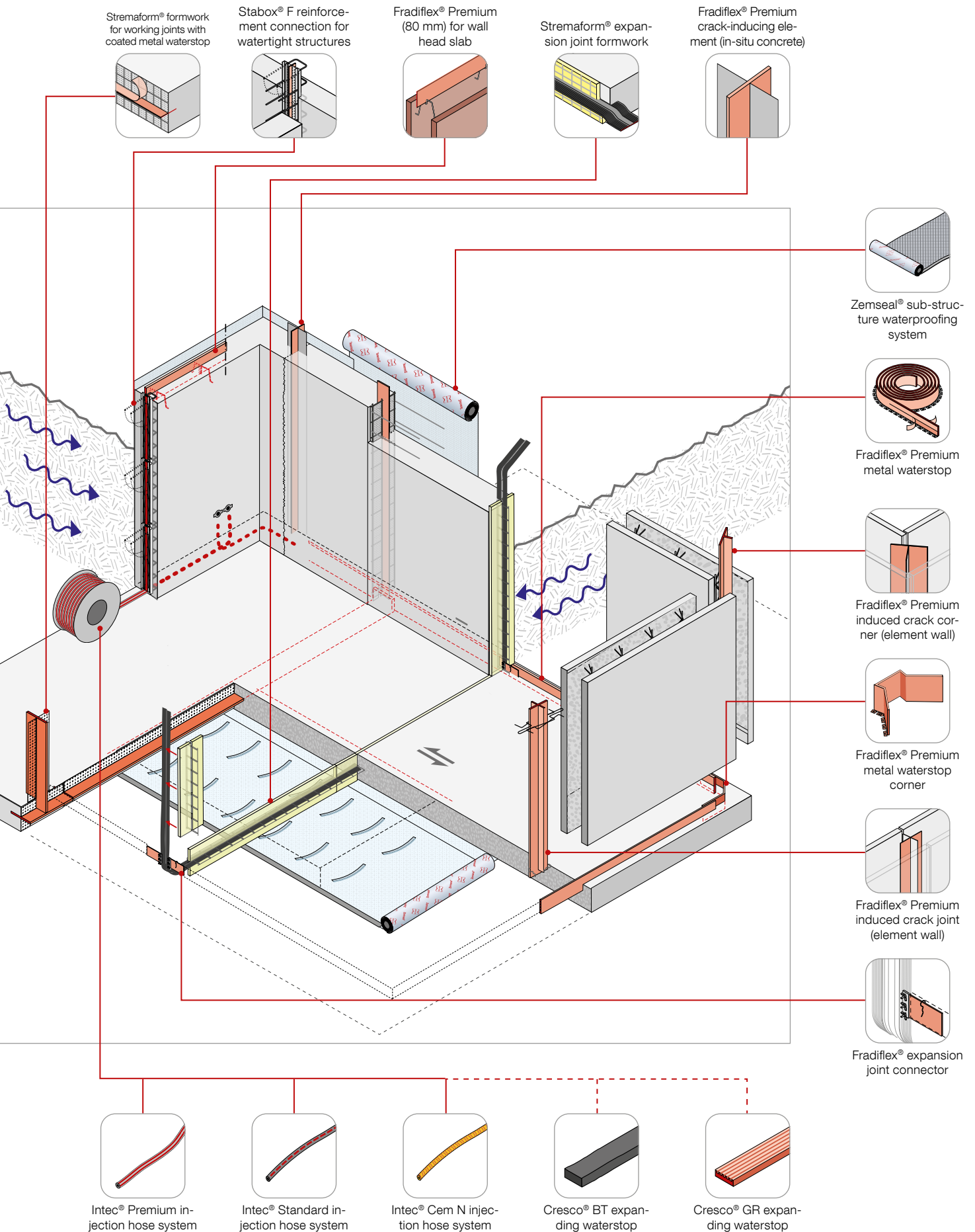

Sub-structure waterproofing

Zemseal® sub-structure waterproofing system

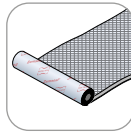

Zemseal®
sub-structure
waterproofing
system

Joint waterproofing

Fradiflex® metal water-stop



Fradiflex®
Premium metal
waterstop

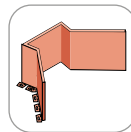

Fradiflex®
Premium metal
waterstop
corner

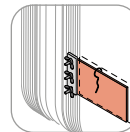

Fradiflex®
expansion joint
connector

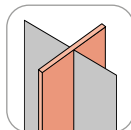

Fradiflex®
Premium
crack-inducing
element (in-situ
concrete)

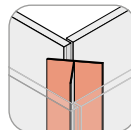

Fradiflex® Pre-
mium induced
crack corner
(element wall)

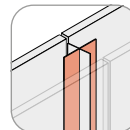

Fradiflex® Pre-
mium induced
crack joint
(element wall)

Intec® injection hose system

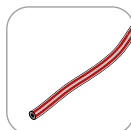

Intec® Premium
injection hose
system

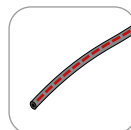

Intec® Stand-
ard injection
hose system



Intec® Cem N
injection hose
system

Cresco® expanding waterstop

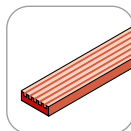

Cresco® GR
expanding
waterstop

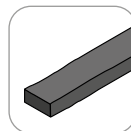

Cresco® BT
expanding
waterstop

Explanations

Structures below ground

These include foundations and footings which are embedded in the ground, as well as underground structures with various uses. There are several challenges for external surfaces below ground: Soil moisture, hydrostatic head, building engineering physics and structural stability.

❑ The execution in reinforced concrete for external surfaces below ground offers the following advantages:

Sealing and load-bearing structure combined (additional sealing not essential).

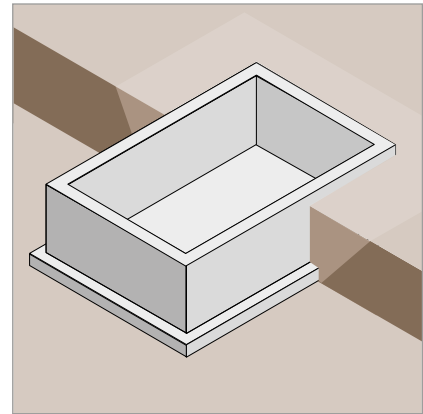

Effects on structures below ground

- Structural influences (earth pressure)
- Chemical effects (chloride, sulphate, radon)
- Water loads of various types:
 - Soil moisture (capillary humidity)
 - Constant and intermittent hydrostatic pressure (ground, stratum or flood water)

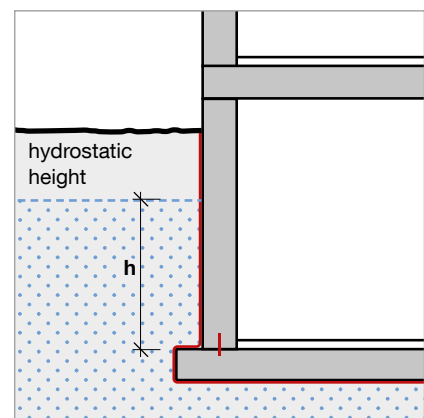

Implementation of waterproof concrete construction

- Defining stress and usage
 - Static dimensioning (component-specific)
 - Waterproofing concept (planning of built-in components, penetrations, joint waterproofing, etc.)
- ❑ For high usability requirements, the combination of an impermeable concrete construction and a sub-structure waterproofing system provides extra benefits.

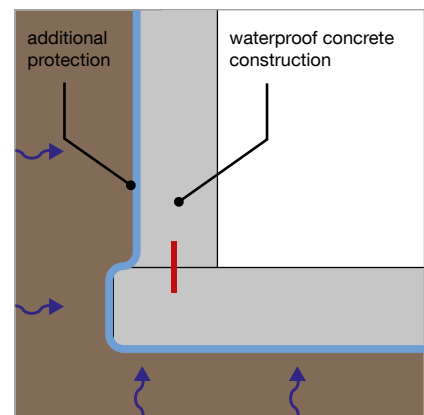

Design variants of an impermeable concrete construction

■ Low requirement

In its simplest form, waterproofing of the structure is undertaken by the concrete members and it is assumed that any cracks will self-seal (defining separating crack widths).

■ Higher requirement

In the case of higher requirements, the technical design should ensure that uncontrolled cracks do not occur (building method without separation cracks).

■ Highest requirement

In the case of extremely high requirements, as well as crack control with the installation of an additional sealing layer (fresh concrete composite film), water penetration is excluded (sub-structure waterproofing system).

■ Joints

All types of impermeable structures made of concrete require corresponding joint waterproofing.

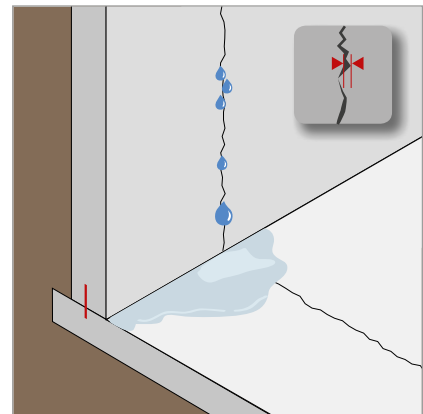

Types of joints in concrete construction

In concrete construction, distinction is made between three different types of joints:

■ Working joints

Divide two concrete pours, according to work sequence or daily sections.

■ Crack-induced joints

Avoid uncontrolled crack formation due to shrinkage deformations during the concrete curing process.

■ Expansion joints (movement joints)

Allow for different structural movements, e.g., due to thermal expansion or settlement of the structure. Sealing must be done with an elastic waterbar.

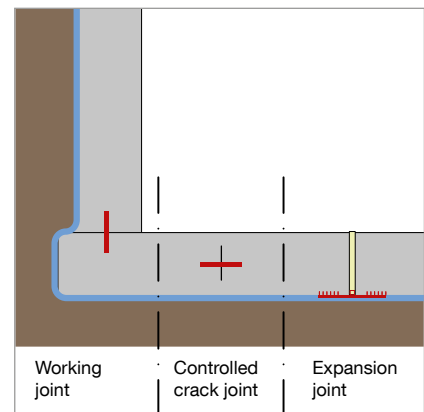

Construction joint sealing variants

Installation of

■ Coated metal waterstop (Fradiflex®)

- Only 30 mm installation depth
- Absorption of minor movements

■ Injection hose (Intec®)

- Injection of resins and cement paste
- Multiple injection possible

■ Cresco® expanding waterstop

- Expands in contact with water
- Installation direct onto hardened concrete

☒ Combinations of existing sealing systems as primary and secondary waterproofing offer maximum safety.

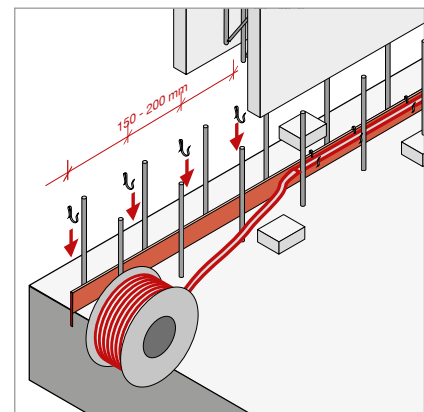

Sealing of crack-induced joints

Crack-induced joints are designed in large-scale concrete structures to prevent uncontrolled, thus unsealed crack formation. Uncontrolled cracks develop from internal structural restraint stresses. Controlled crack cross sections are formed by a crack-inducing element, which weakens the concrete by at least one third of the cross section, and a sealing solution which generally consists of a coated metal waterstop. Thus, the restraint stresses are dissipated and the resulting joint is sealed.

❑ In the case of semi-prefabricated members, such as twin walls, each joint is formed as a controlled crack cross section, so that a crack develops at this point, according to design.

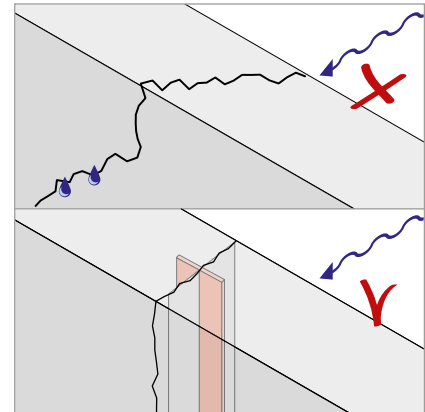

Division with crack-induced joints

As an alternative to the formation of shrinkage channels, large concrete elements can also be manufactured in a single casting by incorporating crack inducing sections. The built-in crack inducing sections ensure that the shrinkage stresses arising during curing are dissipated by systematic crack formation. At the same time, the cracks are sealed by a built-in, coated metal waterstop. In this situation, a design with Stremaform® crack inducing formwork and a coated metal waterstop is recommended (Fradiflex®).

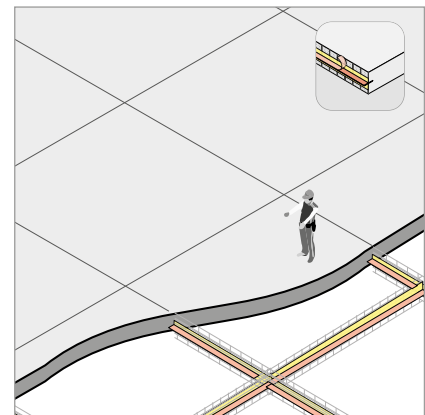

Sealing of expansion joints

These are used in large structures when thermal influences or other expected movements would cause damage to the components. Expansion joints can be one or two dimensional. The joints are waterproofed using waterbars. These can be made of PVC-P or rubber. The installation process is considerable according to choice of material. The expansion joint waterbars generally comprise a central hose which can absorb the deformations. The waterbars are available as internal or external variants. These must have a relatively long embedment length within the components and a very good concrete lining.

❑ The expansion joint waterbars and coated metal waterstops can simply be connected with prefabricated units.

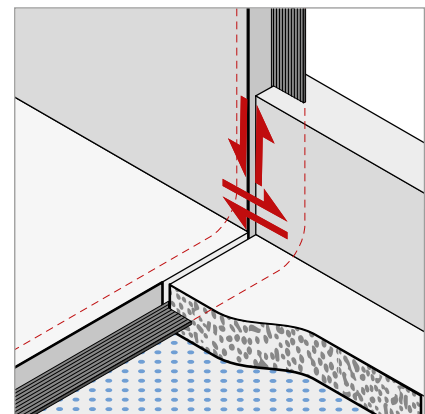

High quality usage

Underground structures face ever increasing usage requirements. A straightforward waterproof construction, in which the concrete cross section undertakes load transfer and waterproofing functions, has not always been found suitable in practice. It is not possible to achieve a defect-free, standard-compliant and building regulation-compliant construction without additional measures. One possibility for planners and clients is to use fresh concrete composite systems in addition to conventional waterproof construction. Sub-structure waterproofing systems are distinguished by their resistance to infiltration and plannable bridging of construction-related and unforeseeable cracks and separating cracks. Also, sub-structure waterproofing systems act as a vapour diffusion and Radon brake and therefore ease compliance with the necessary building physics requirements in high-quality usage.

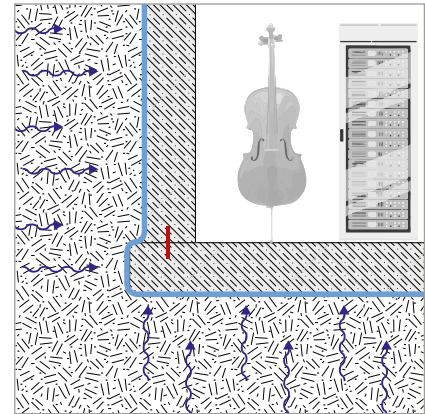

Safety, even beneath the floor slab

Floor slabs can be optimally secured against penetrating ground water by sub-structure waterproofing systems. Complex geometries such as floor slab projections or haunches are easily executed. FBV systems are also a good choice with single-sided formwork for confined construction zones, with no access to the water side. Hard-to-access areas are permanently and properly protected.

■ The whole building shell below ground can be completely protected with the MAX FRANK Zemseal® sub-structure waterproofing system.

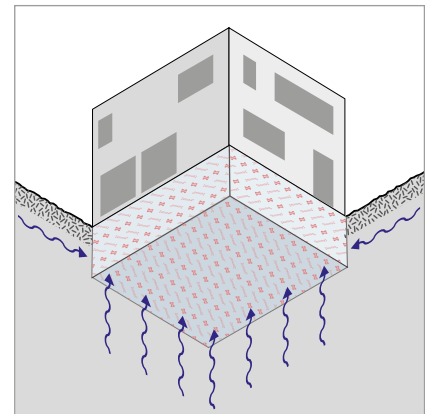

Unavoidable cracks in concrete

Even with the most careful planning and execution, crack formation in concrete is unpredictable - both qualitatively and quantitatively. The smaller the design crack width, the less precise the calculation of expected cracks. The hydration behaviour is also extremely dependent on the ambient conditions during the concreting and the post-treatment measures. Unanticipated load cases or temporary effects on the supporting structure can also lead to uncontrolled crack formation. Without planned measures on how to control such cracks, uncontrolled cracking can lead to unwanted water ingress or moisture damage. Zemseal® can be used as a planned measure. It creates a watertight bridge over the cracks, irrespective of when they form (e.g. subsequent stresses).

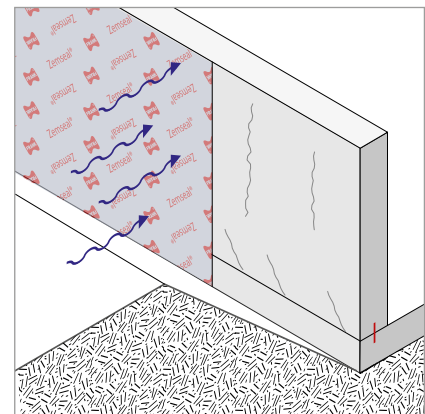



BUILDING
COMMON GROUND

Zemseal[®]

Sub-structure waterproofing
system



Zemseal® sub-structure waterproofing system

Construction seal with high quality usage of basements

Additional waterproofing measures are usually required to meet all the structural and physical requirements that arise in waterproof structures. In the case of high usage requirements, the use of a safe, fresh concrete composite system has proven its worth. Our Zemseal® FBV system encloses the water-impacted building components and forms a secure and integral external waterproof protection. MAX FRANK Zemseal® FBV technology combines mechanical and adhesive bonding - "dual-bond" technology.

★ Advantages

- Dual-Bond Technology: mechanical and adhesive bond
- Tested leakage protection
- Excellent crack bridging
- High material efficiency (only 50 mm joint overlap)
- Suitable for high-pressure cleaning
- Simple handling due to low roll weight
- Effective diffusion barrier - protection against radon gas
- European Technical Assessment (ETA)
- German National Approval

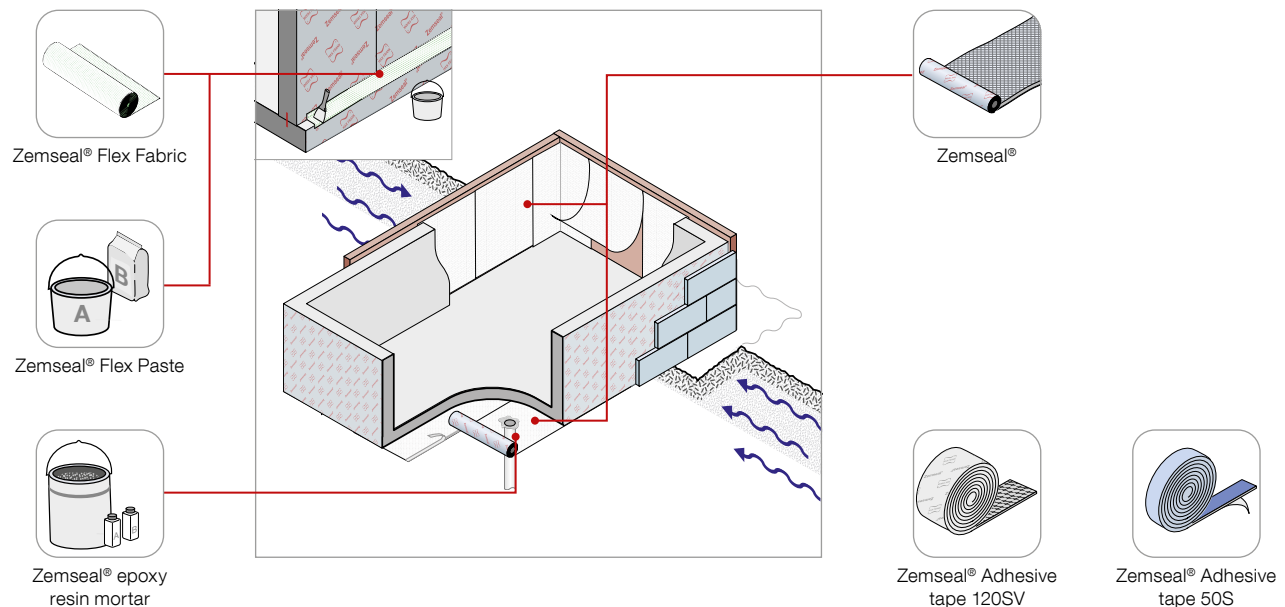

Technical Information

Waterproof construction plus sub-structure waterproofing system

Structures below ground face ever increasing usage requirements. These usage requirements determine the quality level of the design. A combination of waterproof construction and a fresh concrete composite membrane offers safety to a very high standard. Sub-structure waterproofing systems are distinguished by their resistance to infiltration and plannable bridging of construction-related and unforeseeable cracks and separating cracks.

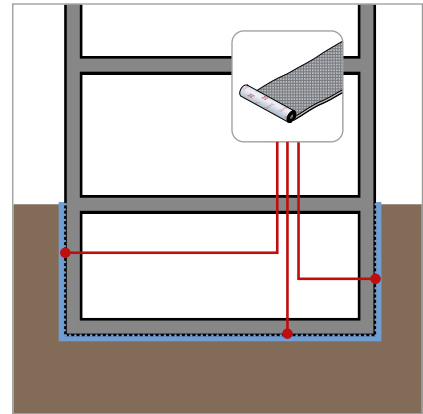

Tested waterproof membrane

The intermediate geotextile layer is treated with a high-quality adhesion agent. The ultrafine woven fibres connect permanently with the cement paste in the alkaline reaction phase during the hydration process. The large surface area of the geotextile produces an additional, surface crimping effect over the concrete edge zone. This bonding between membrane and concrete avoids infiltration of water beyond a damaged spot. This guarantees reliable waterproofing.

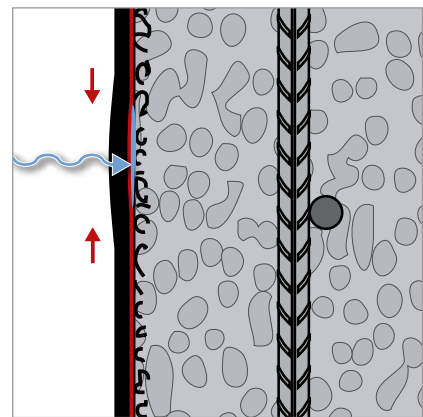

Dual-Bond technology: Mechanical and adhesive bonding mechanism

The bond between Zemseal® and concrete consists mainly of two different components, which both prevent lateral water migration:

Mechanical bond

The roughness of the fleece allows concrete slurry to fill the gaps and “interlock” with the fibres of the fleece. During concrete compaction, fine particles of the concrete are migrating into the fleece.

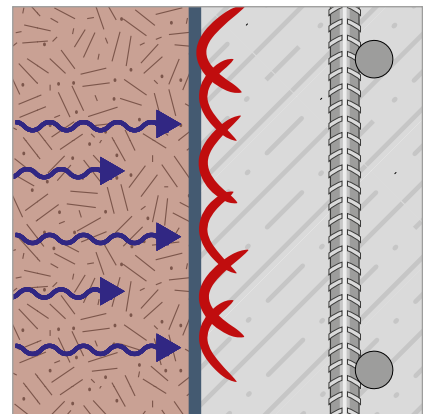

Adhesive Bond

During manufacturing, the fleece is soaked with a bonding agent (Acrylat Copolymer), resulting in an increased surface roughness of the fleece fibres and better adhesion of the concrete particles.

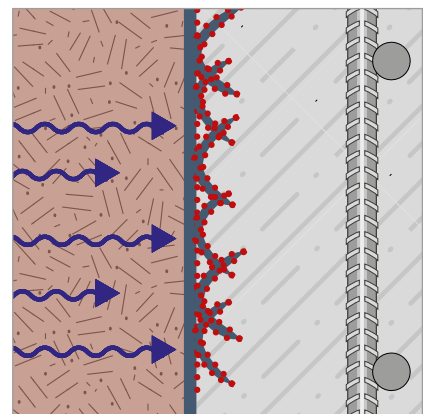

Effective diffusion barrier - protection against radon gas

In spaces with increased and/or very high use requirements it is essential to observe physical building parameters. Take the ingress of gas and/or water in vapour phases into consideration. Using Zemseal® enables planners to anticipate and calculate these hard-to-quantify transport mechanisms. Zemseal® protects, amongst other things, against penetrating Radon gas and functions as an effective vapour diffusion brake, protecting the concrete against chemical attacks.

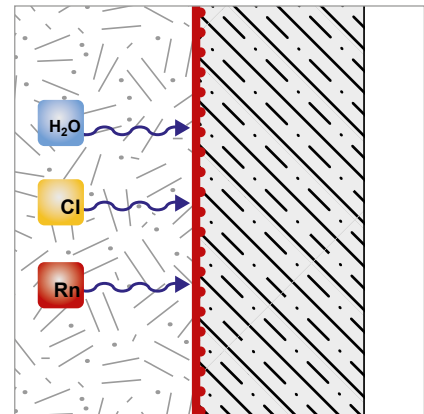

Minimizing the risk of necessary renovations

During early planning stages, important design decisions are made which can impact the build quality of the whole structure. Fixtures such as flooring, screed and drywall can conceal important accessibility points. If something goes wrong, these features can be time-consuming to dismantle or to remove. Accessibility points must be guaranteed in order to carry out necessary waterproofing work, whilst keeping costs and disruption to a minimum.

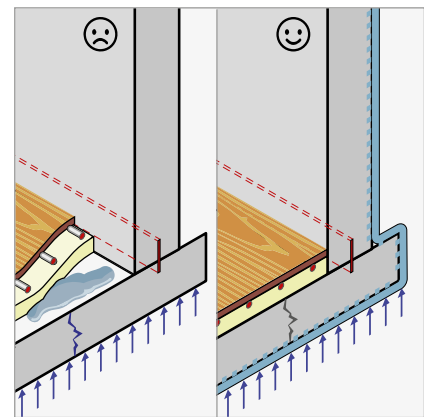

Product variants

Zemseal® sub-structure waterproofing system

With leakage protection

- The film has a double layer of thermal laminate.
- A high-strength, extremely chemical and temperature-resistant polypropylene plastic membrane forms the waterbearing side.
- Weather-independent installation due to self-adhesive strips



Type overview

Type		05	08		12
Length	m	20.00	20.00	20.00	20.00
Width	m	1.00	1.00	2.00	2.00
Weight	kg/roll	11.20	15.20	30.40	36.40
Application		Wall	Wall / floor slab		Floor slab

Proof of usability

CE marking according to European Technical Assessment (ETA)

The ETA (European Technical Assessment) is a product performance assessment on European level that leads to CE marking. The product properties and the product performance are defined in the ETA and are confirmed by the manufacturer in the Declaration of Performance (DoP). To receive and to maintain an ETA, comprehensive tests and ongoing quality control are necessary - to ensure highest product quality.



Proof of usability

Ü-mark according to a German national test certificate for a construction product (allgemeines bauaufsichtliches Prüfzeugnis abP)

The German National test certificate for a construction product is a verification of fitness for use according to German Standards, which declares product properties and product performance. The construction product is then to be marked with the Ü-mark. Comprehensive tests and verifications guarantee a product which is ideally suited to the requirements.



Functional principle of the Zemseal® sub-structure waterproofing system

Sub-structure waterproofing systems are distinguished from other on-roll sealing materials due to their permanent and laminal adhesion to the concrete, resulting in protection against leakage of the sealing plane in the event of damage. The Zemseal® system forms a water-tight enclosure, protecting the components against cracking and water ingress.

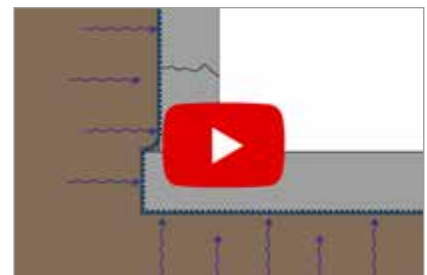
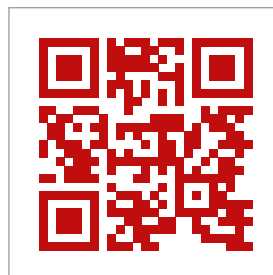

System components

Zemseal® adhesive tapes

- The 120SV acrylic tape with non-woven backing is a special fleece tape for sealing fittings, membrane damage or butt joints on the concrete side.
- The double-sided 50S acrylic adhesive tape is used to attach Zemseal® membranes on vertical and inclined surfaces, and for producing tape head butts.



Zemseal® epoxy resin mortar

- Solvent-free, chemical-resistant, multi-component epoxy resin mortar
- For force-fit and sealing connections of Zemseal® waterproofing membrane to adjacent building components



Zemseal® Flex paste

- Design of floor slab overhangs as pressure-watertight transition between floor slab and wall
- Surface sealing in accordance with DIN 18533 and for gluing the entire surface of thermal insulation on the FBV membrane



Zemseal® Flex fabric

- Textile for reinforcement of Zemseal® Flex Paste
- This can be used on its own as strip or surface seal
- The use of the glass fibre membrane is necessary to achieve the necessary strengths





MAX FRANK

BUILDING
COMMON GROUND

Fradiflex®

Metal waterstop



Fradiflex® metal waterstop

Waterstop for working joints

All concrete structures in contact with the ground must be sealed against ground moisture, seepage water or pressurized water. Our Fradiflex® metal waterstop system meets all requirements for the secure sealing of water-impermeable structures. The flexible special coating bonds with the concrete, creating an adhesive barrier seal that prevents water from circulating. The system can be used for the reliable sealing of construction and predetermined crack joints in in-situ concrete construction and with element walls.

★ Advantages

- More safety due to fewer splices (roll)
- Simple position protection due to fixing angle
- Tested up to 5.0 bar water pressure (usable according to ETA and abP up to 2.0 bar)
- No welding necessary at the joints
- Fast installation thanks to two fixing points (crack inducing elements)
- Stable crack inducing elements (secure standing and position)
- European Technical Assessment (ETA)
- German National Approval

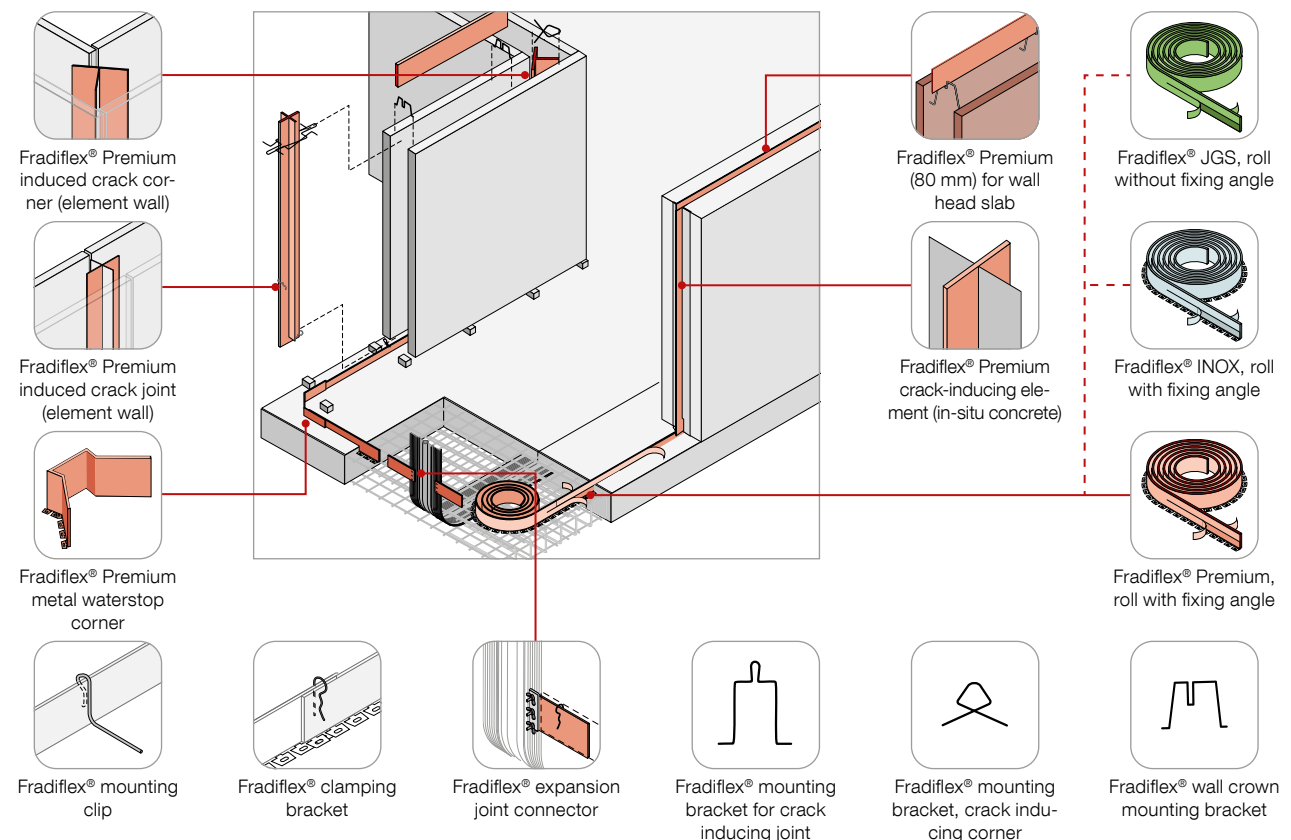

Technical Information

Product structure

Fradiflex® is a coated metal waterstop for sealing construction and predetermined crack joints in concrete construction. The advantages result from the practice-oriented structure:

1. Galvanized steel sheet (thickness 0.6 mm) or stainless steel sheet (0.5 mm)
2. Special coating based on thermoplastic elastomer
3. Integrated mounting brackets for easy installation
4. Split protective foil (can be peeled off separately for 1st and 2nd construction stage)
5. Upper foil strip as protection against soiling for 2nd construction stage
6. Joint sheet roll for minimum number of joints

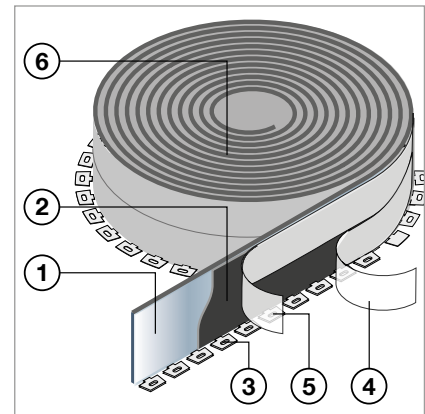

Product structure of induced crack joint

1. Steel sheet (thickness 1.5 mm) as sealing sheet with special coating
2. Steel sheet (thickness 1.0 mm) for crack induction
3. Protective foil
4. Lengths 2.50 m and 3.00 m can be extended with connecting set

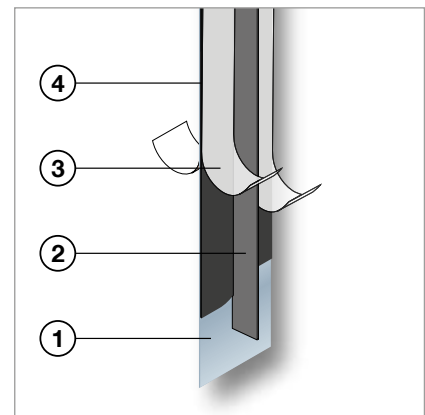

Functionality

Fradiflex® metal waterstop already bonds with the fresh concrete due to the adhesive coating, the metal waterstop blocks the passage of water in the joint. The special coating prevents a water-bearing gap from forming between the concrete and the metal waterstop. At the same time, the coating additionally protects the metal waterstop from chemical influences (e.g. from contaminated groundwater).

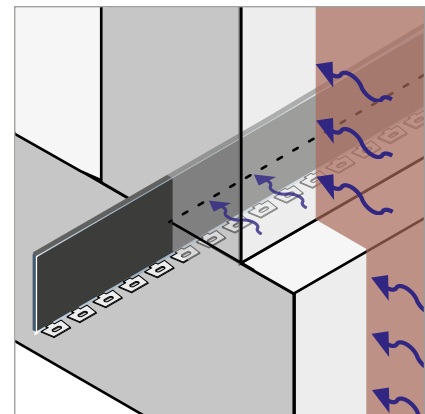

How metal waterstops work in crack-inducers and working joints

Metal waterstops form a water seal in a joint. In the case of crack-induced joints, the crack is additionally induced within the joint.

1. Metal waterstops form a circulation extension in the joint/crack area (labyrinth principle). As a result, penetration of the water is prevented. If uncoated, the sheet metal width is usually 250 or 300 mm, the thickness is 1.5 mm, and the butt joints must be welded. (Embedment depth: half sheet thickness)
2. Metal waterstops with an elastic coating bond connect the concrete to the metal waterstop. The adhesive connection prevents water creepage. Thanks to the coating, the joint is watertight even with small movements of up to 1 mm, and the sheet metal width can be reduced to 150 mm. Butt joints are simply glued thanks to the coating. (Embedment depth: 30 mm)

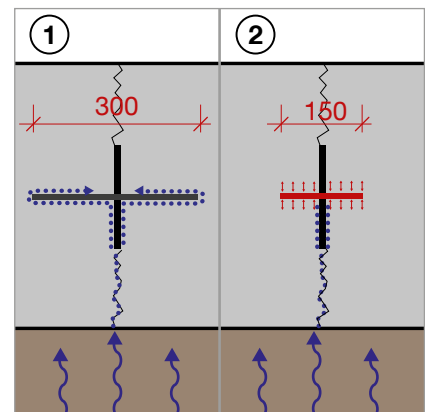

Induced crack joints are planned cross-sectional weakenings in which shrinkage stresses from the setting process of the concrete are specifically relieved in large-area structural components.

1. Fradiflex®: The deformations are absorbed in the permanently elastic coating on both sides and remain reversible. The sealing of the joint becomes effective immediately.
2. Metal waterstop with rigid bond: the bond with the concrete must be dissolved so that the joint gap can open. If the bond between the sheet and the concrete is greater than the tensile strength of the concrete, cone-shaped breakout bodies will occur.

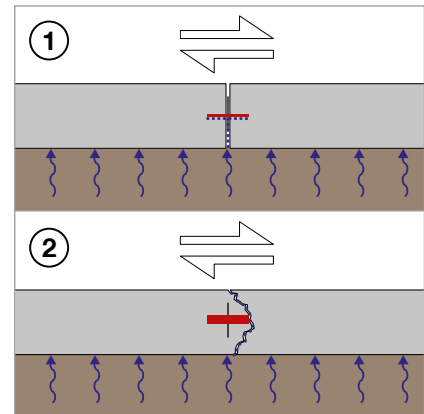

Floor slab/wall working joint

The working joint between the floor slab and the wall can be sealed in different ways:

1. If a PVC or elastomer water bar is used, an upstand will usually be required in order to guarantee the necessary embedment depth (1/2 of the width of the rubber water bar) in the floor slab. Butt-joints in the water bars must be welded or rubberised. Due to the elasticity of the rubber water bar material, it must be fixed with clamps or clips prior to concreting. Nevertheless, flaws in the sealing level can easily occur here through displacements.

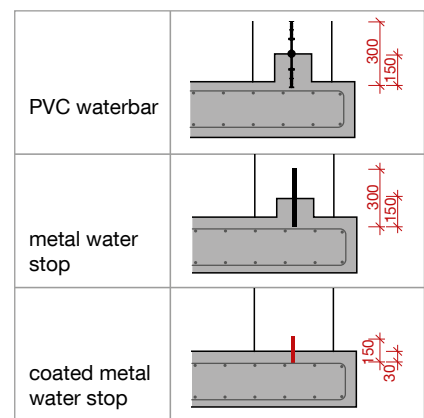

2. An upstand is similarly necessary if an uncoated metal waterstop is used, as in this case, half of the metal waterstop with a minimum width of 250 or 300 mm must be embedded into the floor slab. The use of uncoated metal waterstops is advisable only in overpressed joints, i.e. mostly in floor slab/wall joints, as hardly any movement is to be expected in the joint here. These sheets are too complex to seal at the butt-joints.

3. **An upstand can be dispensed with if a coated metal waterstop is used to seal the floor slab/wall working joint. Coated metal waterstops require an embedment depth of 30 mm in the floor slab.**

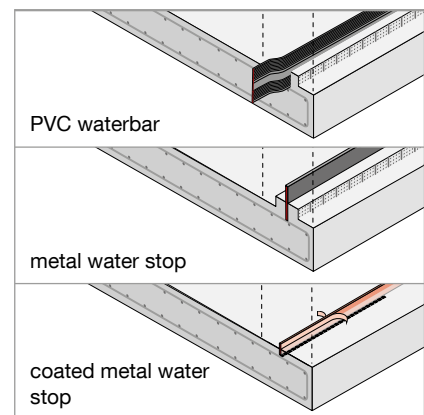

Crack-induced joints for horizontal installation

The lower reinforcement layers are installed first.

Then the crack inducing sections are fixed, in the middle of the structural component, with the help of the mounting brackets.

A: with fastening to the top reinforcement

B: with supports on the bottom reinforcement

After that, the top reinforcement is added. Through the targeted reduction of the concrete cross-section and the reinforcement, the shrinkage stresses can be dissipated in these areas. The sealed crack inducer is created in this way.

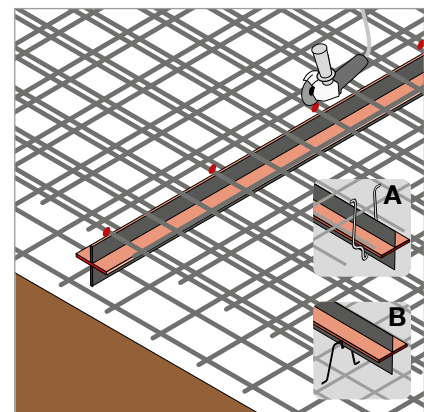

Crack-induced joint in the wall

Due to the crack-inducing section, the concrete cross-section is reduced by at least 1/3. In many cases the horizontal reinforcement is also reduced. The specifications in the reinforcement plan must be adhered to.

After removing the protective film, the crack-inducing section is now pushed into the desired position and pressed against the horizontal metal waterstop, and the bond thus created is secured with clamps. The width of the crack-forming sheet must be selected according to the slab depth.

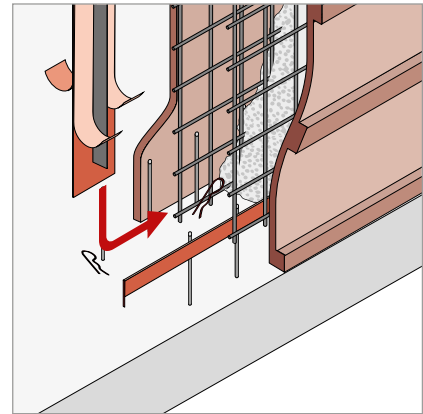

Design of the twin wall crack inducing joint

The width of the crack-forming sheet must be selected according to the slab depth. Since the concrete cross-section has to be reduced by 1/3, an implementation with 2 x 50 mm crack plate width, together 100 mm > 1/3 of the wall thickness, must be chosen for a 300 cm-thick wall.

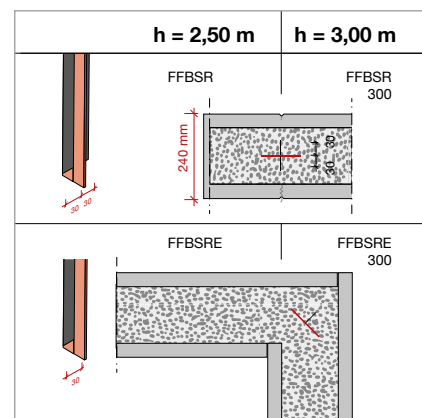

Twin wall butt joint

The formation of cracks is very simple with Fradiflex® crack inducing section. After removing the protective film, the coated vertical crack inducing section is aligned with the horizontal joint waterproofing as a T butt-joint and fixed via the overlap. The butt-joint is additionally secured on both sides with clamps. No drill holes or screw connections are required.

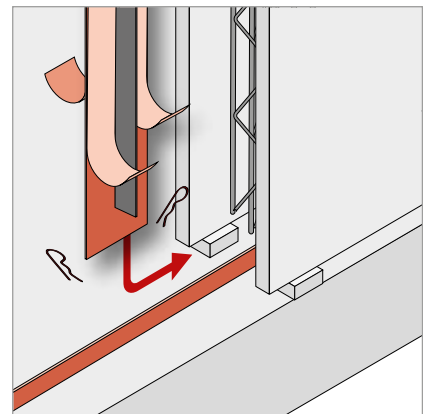

Element wall corner

Element walls are butted at the corners due to the system. Fradiflex® induced crack corner (element wall) should also be installed here. Fradiflex® induced crack corner elements can be used for both inside and outside corners. In order to achieve a clean connection to the horizontal metal waterstop, the pre-bent metal waterstop corner must also be installed in the horizontal waterstop at the base point.

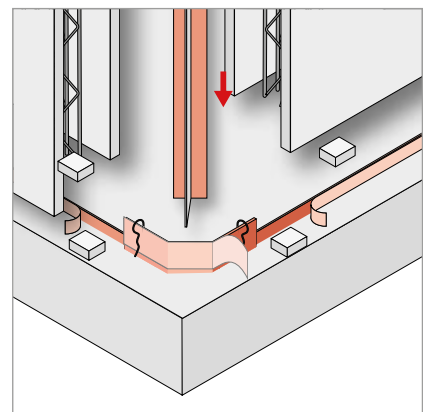

Fixing in the wall head

The crack-induced joints are secured to the top edge of the wall with two fixing brackets. Due to the rigidity of the T-element, no further interim fixing is necessary. To avoid deformations, however, it is important to observe the layer-wise introducing of the concrete on both sides up to a maximum height of 500 mm.

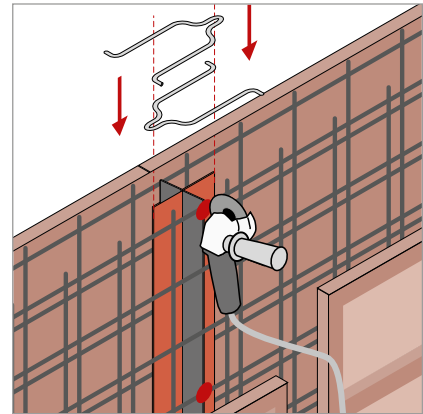

Wall head to ceiling fixing

Through the use of the appropriate metal waterstops, all working joints can be reliably sealed, even if there are several basement levels. The metal waterstops are to be placed underneath and above the ceiling. Reliable joint planning can be done simply and securely. All details can be implemented with Fradiflex® metal waterstops.

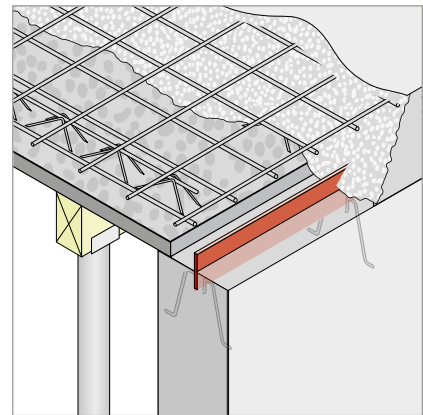

Product variants

Fradiflex® Premium metal waterstop

Joint waterproofing for waterproof concrete structures

- Area of application: Components, ceilings and roofs in building and commercial construction
- Can be installed directly on the upper reinforcement layer
- You can order a roll or straight elements
- Available with or without fixing bracket
- Clamping brackets are supplied as accessories



Fradiflex® JGS metal waterstop

Joint waterproofing for agriculture constructions

- Scope of application: tanks, stable structures and solid manure plates
- Galvanized steel sheet with double-sided special coating
- Available with or without fixing bracket
- Clamping brackets are supplied as accessories
- Approval for up to 8 m filling height
- National technical approval (abZ)

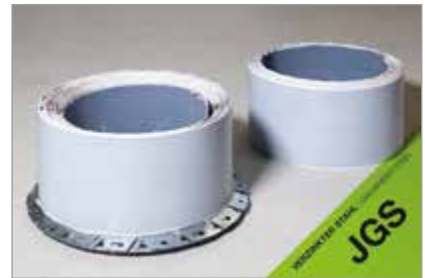

Fradiflex® INOX metal waterstop

Joint waterproofing for aggressive substances and agriculture constructions

- Scope of application: Driving silo (national approval), chlorinated water and salt water
- Stainless steel metal with double-sided special coating
- Available with or without fixing bracket
- Clamping brackets are supplied as accessories
- Approval for up to 8 m filling height
- National technical approval (abZ)



Fradiflex® Premium metal waterstop corner with double-sided special coating

- Essential if using the crack-inducing corner element for twin walls, to achieve a clean connection with the metal waterstop
- Pre-edging ensures ideal position for different wall widths
- Simple position protection due to fixing angle



Fradiflex® expansion joint connector

Connecting metal waterstop and pvc/rubber waterbars

- Galvanised steel sheet with special coating on one side
- The clamping connection consists of Cresco® expanding waterstop and a presser plate
- Protected against water ingress up to 5 bar (50m water head)

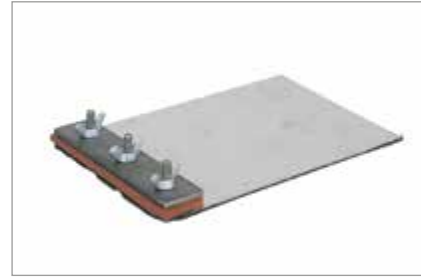

Fradiflex® Premium crack-inducing element (in-situ concrete) with special coating for in-situ concrete joint

- Crack inducing element in connection with metal waterstop forms a secure waterproofing system
- Planned dissipation of shrinkage cracks by weakening of the concrete cross section
- Good inherent stability of the units
- Fast, easy installation - no welding, no drill holes



Fradiflex® Premium induced crack corner (element wall) with special coating for twin wall crack-inducing corner

- The geometry of the floor slab and of the mounting bracket permits secure waterproofing of twin wall slabs
- The formwork orientation is irrelevant here
- Due to the double-sided coating, it is suitable as both an inner and an outer corner



Fradiflex® Premium induced crack joint (element wall) with special coating for twin wall-controlled crack-induced joint

- Reliably seals the butt joints
- The controlled crack joint element has excellent inherent stability
- Pressure at the base provides stability for the unit.
- In the upper wall area, the Fradiflex® fixing loop secures the sealing element
- Generates the required cracks in the concrete member in a targeted and controlled way



Type overview

Execution	Roll			Straight			Crack inducing element	
	Yes	No	No	Yes	No	No	No	No
Fixing bracket								
Length	m	25.00		2.10			2.50	3.00
Height	mm	150	80	150	80	depending on slab depth		

Further versions on request.

System components

Fradiflex® connection set for crack inducing elements

- Fixed with clamping bracket and crack plate clamps
- For extension of crack-inducing sections



Proof of usability

CE marking according to European Technical Assessment (ETA)

The ETA (European Technical Assessment) is a product performance assessment on European level that leads to CE marking. The product properties and the product performance are defined in the ETA and are confirmed by the manufacturer in the Declaration of Performance (DoP). To receive and to maintain an ETA, comprehensive tests and ongoing quality control are necessary - to ensure highest product quality.



Proof of usability

Ü-mark according to a German national test certificate for a construction product (allgemeines bauaufsichtliches Prüfzeugnis abP)

The German National test certificate for a construction product is a verification of fitness for use according to German Standards, which declares product properties and product performance. The construction product is then to be marked with the Ü-mark. Comprehensive tests and verifications guarantee a product which is ideally suited to the requirements.



Application video for Fradiflex® Roll

With the Fradiflex® coated metal waterstop, sealing of the working joint between the floor slab and the rising wall in the form of a “white tank” can be achieved in a time-saving manner. Fradiflex® is recognised on building sites due to its easy installation at the prefabricated fixing angles, as well as the temperature bandwidth of the bitumen-free special coating.



How to

Professional transition between working joint seal with coated metal waterstop and an expansion joint waterstop.

Due to the expected movements, expansion joints must be formed using expansion joint waterstops with care and precision.

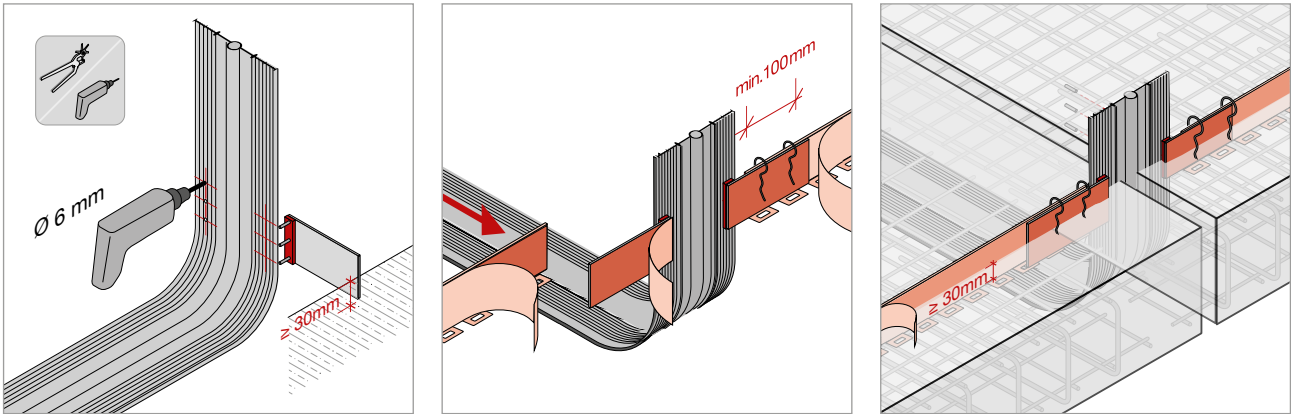

Injection hose as secondary seal for joint waterproofing with coated metal waterstop

Coated metal waterstops have proven themselves over many years as reliable joint waterproofing in construction. However, if the risk of joint leaks remains high, a subsequent securing system should be fitted, even in new buildings. Installing an injection hose allows the concrete joints to be injected at a later point and resealed accordingly.

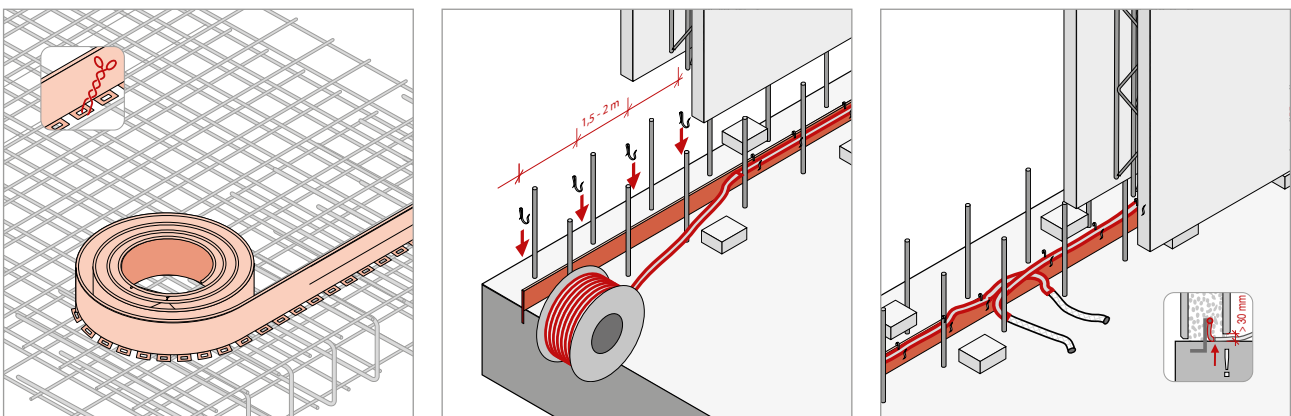



MAX FRANK

BUILDING
COMMON GROUND

Intec®

Injection hose system



Intec® injection hose system

Sealing of concrete working joints

Intec® injection hose technology seals horizontal and vertical construction joints in impermeable structures safely and quickly. The suitable injection hose in combination with the suitable injection material result in an approved system. As additional construction joint protection, a combination of the injection hose with other joint sealing systems can also provide increased sealing safety. The extensive range of accessories and tested grouting materials are helpful for installers in practice.

★ Advantages

- As primary and secondary sealant
- Patented multiple injection
- Injection circuit lengths up to 30 m
- Injection hose does not sinter during concreting
- Tested up to 5.0 bar water pressure (usable according to abP up to 2.0 bar)
- German National Approval

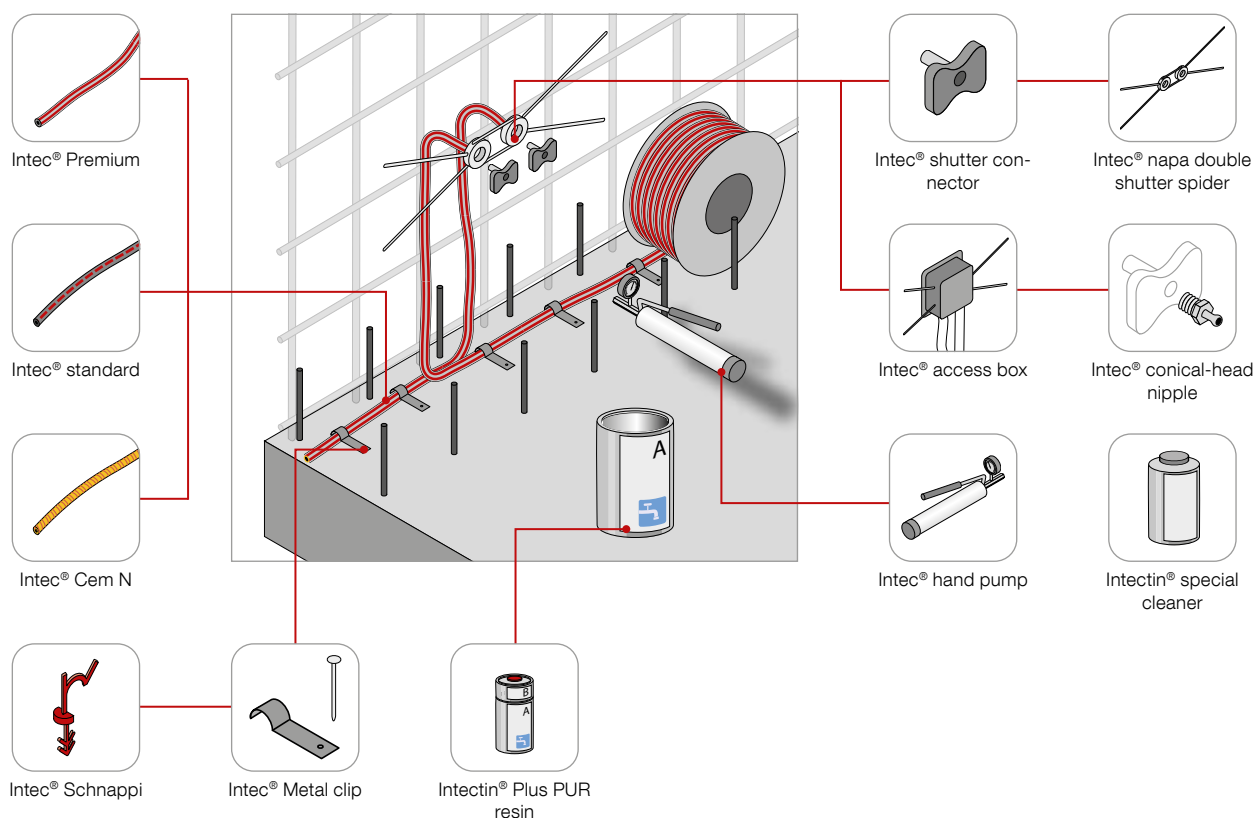

Product variants

Intec® Premium injection hose system

Multiple injection with polyurethane resin

- Drainage with simple pressure flushing
- No expensive vacuuming required
- Material: Internal hose with aperture and braiding
- Possible injection materials: Polyurethane resin, epoxy resin, acrylic resin etc.
- German National Approval (abP)
- Proof of multiple injection with Intectin® Plus polyurethane resin (emptied with pressure flushing)
- German National Approval (abP) for multiple injection with Intectin® Plus (polyurethane resin)



Intec® Standard injection hose system

Single injection with resin

- Well-established method for the injection of joint systems
- Optimum spacing of the outlet slots for continuous sealing
- Material: Hose with aperture, without braiding
- German National Approval (abP)
- Tested with Intectin® Plus polyurethane resin



Intec® Cem N injection hose system

Multiple injection with resins and cement

- Interlocking injection and/or backfilling of any cavities with cement paste or cement suspension
- The hose can be reused after vacuum-emptying
- Multiple injection with cement suspension has been tested by TU Munich
- Material: perforated hose with braiding
- German National Approval (abP)



Proof of usability

Ü-mark according to a German national test certificate for a construction product (allgemeines bauaufsichtliches Prüfzeugnis abP)

The German National test certificate for a construction product is a verification of fitness for use according to German Standards, which declares product properties and product performance. The construction product is then to be marked with the Ü-mark. Comprehensive tests and verifications guarantee a product which is ideally suited to the requirements.



System components

Intectin® injection materials

- Intectin® Plus: 2-component elastomer-resin on polyurethane basis with CE symbol and approval for drinking water
- Intectin® EP: Two-component epoxy resin
- Intectin® special cleaner
- Intectin® Blitz: Foam-producing, damp-curing polyurethane resin



Description	Possible injection materials				Injectability	
	PUR	EP	Cement sus- pension	Cement paste	Simple	Multiple
Intec® Standard	+	+	-	-	+	-
Intec® Premium	+	+	-	-	+	+
Intec® Cem N	+	+	+	+	+	+

⊕ suitable ⊖ not suitable

Intec® Premium and Intec® Standard Components

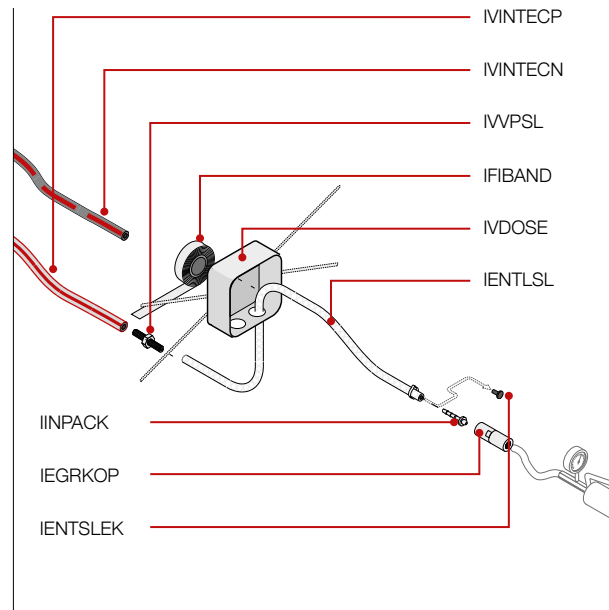
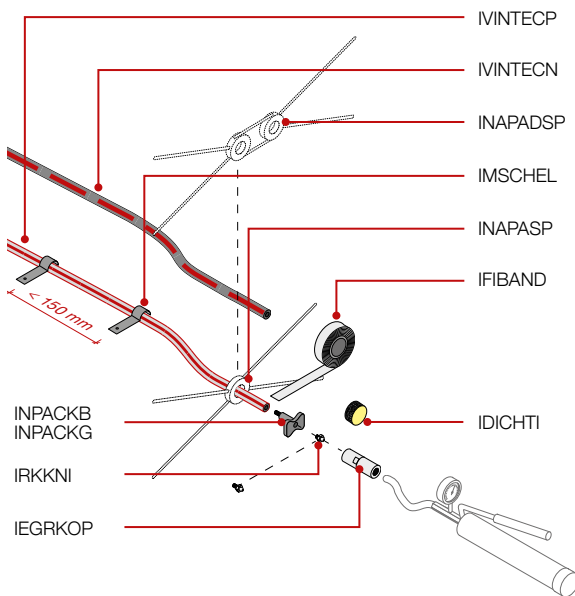

Intec® Cem N injection hose - components

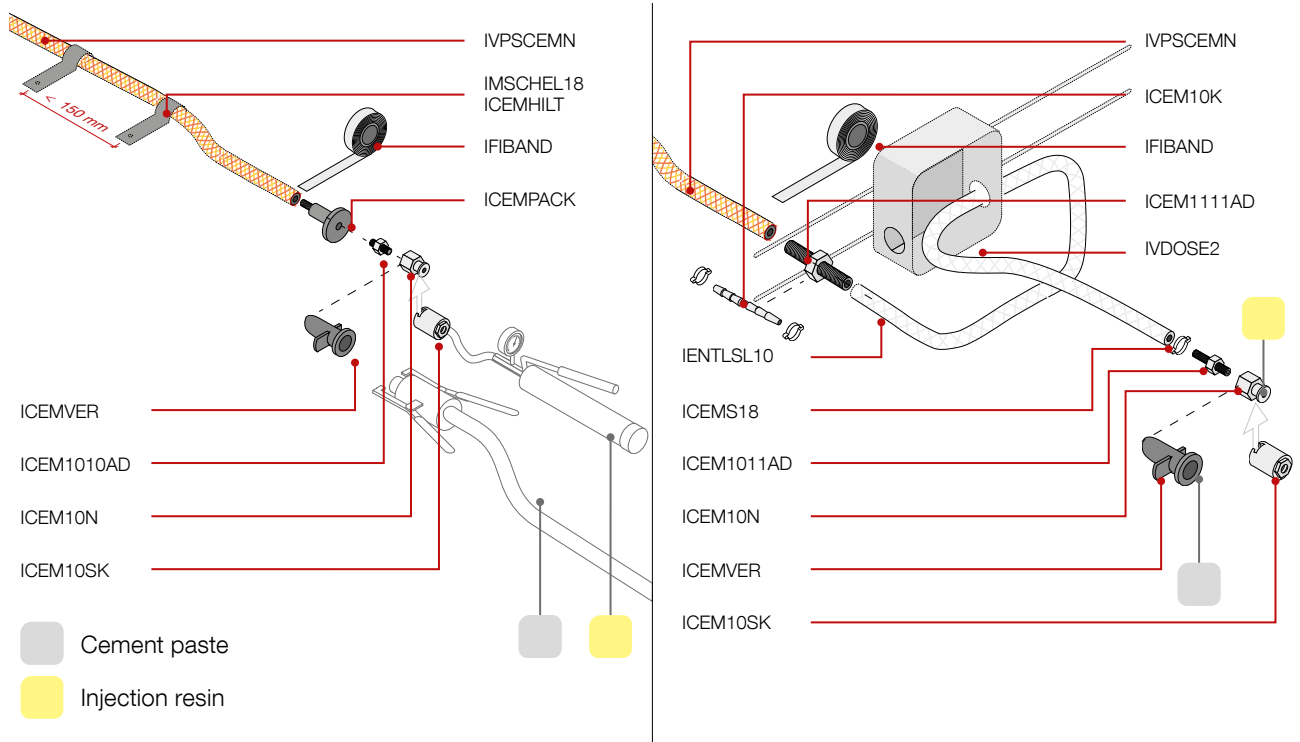

Applications

Injection with resins with Intec® Premium and Standard

The injection with polyurethane resins (PUR) is used for the pressure water-tight sealing of concrete working joints. Empirical value: Average resin consumption around 1 - 1.5 litres / 10 m joint. A robust hose system for multiple use is available through the Intec® Premium injection hose. By means of patented compressed air flushing, the hose is flushed free after injection, so the joint can be injected again at a later time.

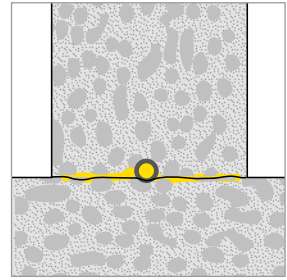

Injection with cement paste with Intec® Cem N

The injection of cement paste and suspensions serves the filling of large volumes. Increased formation of voids often occurs in the case of underpinning and difficult concreting tasks. These flaws can thus be closed and sealed in a planned and targeted manner. The Intec® Cem N injection hose system can also be injected multiple times with different media.

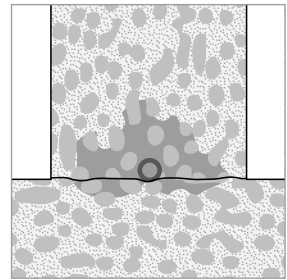

Application film: multiple injection

In this application video we show you the Intec® Premium injection procedure in detail. You can look directly into the concrete working joint through a Plexiglass panel fixed to the test specimen. So that you can follow the sequence more easily we have dyed the polyurethane resin Intectin Plus. See how the Intec® technology works for yourself.



Application film for crack injection

This video demonstrates how dry, wet or water-conducting cracks and joints are correctly injected using screw packers and injection grout. The setting of the packers, the preparation of the crack or joint, the injection, the cleaning of the tools employed and the cosmetic finishing work are illustrated graphically.





MAX FRANK

BUILDING
COMMON GROUND

Cresco®

Expanding waterstop

Cresco® expanding waterstop

Sealing in water change zones

Cresco® expanding waterstops are particularly used for difficult geometric joint courses. These prevent the penetration of water in the construction joints of impermeable concrete structures. When water enters, the swelling process begins and creates a sealing effect. Our Cresco® GR is a rubber-based swelling tape which remains stable in its form and the sealing is achieved by the increase in volume and the swelling pressure. The bentonite-based swelling tape Cresco® BT also expands into cavities and cracks due to its volume increase.

★ Advantages

- Long-lasting expansion capacity
- Excellent dimensional stability
- Controlled limited expansion
- Reliable solution for pipe sealing
- Suitable for water exchange zones
- Tested up to 5.0 bar water pressure (usable according to abP up to 2.0 bar)
- German National Approval

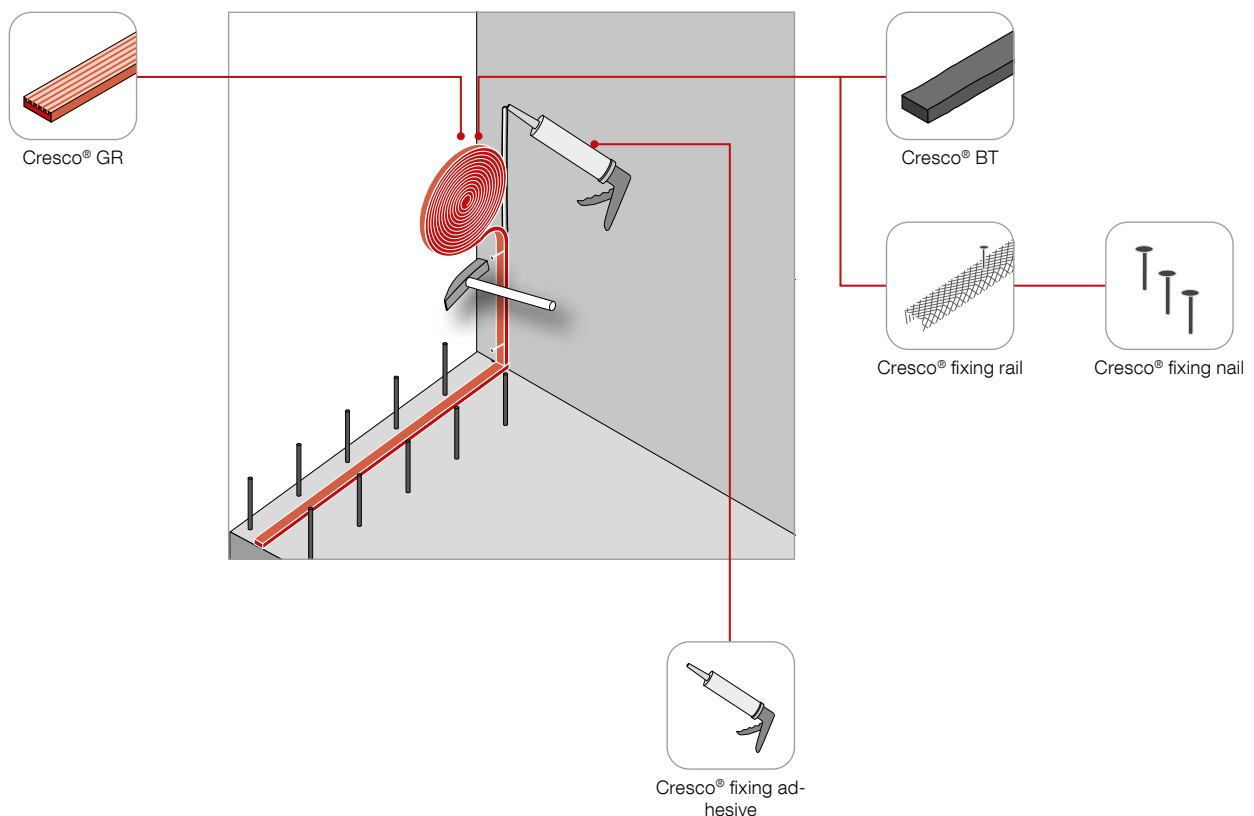

Product variants

Cresco® GR expanding waterstop

Dimensionally stable synthetic rubber base

- Expansion is completely reversible
- No concrete spalling
- Excellent chemical resistance
- Hydrophilic expanding waterstop with ribbed profile
- Waterproofing effect according to the labyrinth principle
- Maximum expansion without concrete spalling
- German National Approval (abP)



Cresco® BT expanding waterstop

Flexible bentonite base

- Dimensional stability
- No upstand required
- High proportion of sodium bentonite
- Outstanding expansion capacity
- Flexibility combined with dimensional stability
- Maximum expansion without concrete spalling
- Seals the finest hairline cracks
- German National Approval (abP)



Proof of usability

Ü-mark according to a German national test certificate for a construction product (allgemeines bauaufsichtliches Prüfzeugnis abP)

The German National test certificate for a construction product is a verification of fitness for use according to German Standards, which declares product properties and product performance. The construction product is then to be marked with the Ü-mark. Comprehensive tests and verifications guarantee a product which is ideally suited to the requirements.



System components

Cresco® fixing adhesive

- For fixing expanding waterstops, on the basis of MS polymers
- Adheres even to slightly damp substrate
- Resistant to weathering and UV radiation



Proof of usability

CE marking according to harmonised European Standards (hEN)

The product is CE marked based on an harmonised European Standard. Product properties and product performance are confirmed by the manufacturer in a Declaration of Performance (DoP). Comprehensive tests and verifications guarantee a product ideally matching the requirements.



Product combinations

Stremaform® formwork for working joints with coated metal waterstop

Stremaform® formwork for working joints with integrated coated metal waterstop 150 mm wide, 1.5 mm thick and coated on one side. The unit is supplied as an exact fit and is installed between the reinforcement layers in the panel or wall.



Stremaform® Crack inducing formwork with coated metal waterstop

The Stremaform® Jointing formwork contains an integrated coated metal waterstop. The reduction of the frictional connection is integrated within the unit..



Stremaform® sound joint with carrying cage for rubber/PVC waterstop

For the water-impermeable sector, the Stremaform® sound joint is additionally equipped with a carrying cage for rubber/PVC waterstop. The PVC waterbar is installed in-situ. With joint inlay, mineral wool 20 mm and carrying cage for rubber/PVC waterstop 150/60-45 mm, single-sided, incl. retaining clip.



Stabox® FD continuity strip

The Stabox® FD double-row continuity strip with variable stirrup width consists of two single sheet steel access boxes, which are connected by an expanded metal profile with an integrated sealing plate coated on both sides. This offers the possibility to connect even larger component dimensions with integrated sealing in a force-locked manner. For variable stirrup dimensions from a stirrup width of 160 cm.



References

SAB Sächsische AufbauBank, Leipzig GER

Due to the high groundwater contamination, a sealing concept with FBV system was planned as an additional measure. SAB Förderbank and its 500 employees move from Dresden to a five-storey office complex in Leipzig. The one hectare building plot on the inner city ring road is heavily polluted with groundwater, so the requirements for the waterproof structure of the building were high. The risk-benefit analysis justified supplementing the waterproof structure with sub-structure waterproofing system Zemseal®. Metal water stop, formwork elements, injection hose system were supplied as further components for a complete watertight system from MAX FRANK (single-sourced).

- ✘ Zemseal® sub-structure waterproofing system
- ✘ Fradiflex® metal water stop
- ✘ Intec® injektion hose system
- ✘ Stremaform® formwork elements



New secondary school, Trostberg GER

The building of the Trostberg State Secondary School has been dilapidated for a long time. The district authorities have therefore decided to erect a new building instead of carrying out a general refurbishment. The future secondary school is divided into three compact, three-storey buildings that form interlocking open spaces.

- ✘ Zemseal® sub-structure waterproofing system
- ✘ Fradiflex® metal water stop
- ✘ Intec® injection hose system



Airport Connection, Zadar HVR

Following the modernisation of the airports in Dubrovnik and Split, Zadar airport was the last in Croatia to undergo extensive development. During the construction of the new terminal building in the port of Gazenica, a connecting section (underpass) to Zadar Airport was planned. Due to the high groundwater level, special attention was paid to the careful selection of materials to protect the structure in contact with the ground from water pressure. A safe construction solution was necessary and Zemseal® sub-structure waterproofing system was therefore chosen..

- ✘ Zemseal® sub-structure waterproofing system
- ✘ Fibre concrete spacers
- ✘ Fibre concrete distance tubes
- ✘ Fradiflex® metal water stop





Homepage / Products

- News
- Projects
- Company
- Careers
- Contact
- Buildings
- Products
- Service
- Download

Product Overview



Products

With a reference search you can pinpoint the exact MAX FRANK product for your solution even faster and more precisely: simple filtering and targeted searches.

Joint

Choose joint

Thermal insulation

Exposed concrete concrete quality

Reset filter

Save search

Formwork

Choose formwork

Sound insulation

Precast element

Sealing

Sealing with concreting

Fire protection

Force transfer

10 results found!



Continuity Strip Stabox - special coating



Continuity Strip Stabox - custom version SD



Continuity Strip Stabox - joint seal



Formwork elements for controlled crack joints Stremaforme with rubber water bar cage



Formwork elements for controlled crack joints Stremaforme with coated metal water stop



Formwork elements for expansion joints Stremaforme with rubber water bar cage and shear force transmission



Formwork elements for working joints Stremaforme - custom shapes



Formwork elements for working joints Stremaforme with rubber water bar cage



Formwork elements for working joints Stremaforme with metal water stop



Formwork elements for working joints Stremaforme with coated metal water stop

Follow us on



MAX FRANK BUILDINGS

The popular tool is integrated in the website and linked with extensive product information. The virtual landscape provides you with the optimal products for the following types of structure: railway station, bridge, office building, high-rise building, industrial building, sewage plant, museum, drinking water tank, tunnel, hydroelectric power station and residential building.



PRODUCT FINDER

Simply filter by the application areas and product properties relevant for you and you will find the ideal product for your requirements.



Joint Designer

The joint designer shows the range of connection joints in concrete structures according to the classification between construction joints, predetermined crack joints, expansion joints, sound separation joints and settlement joints.



ALWAYS UP TO DATE

Never miss out! We keep you updated about new products, the latest software and special solutions. Simply sign up for our newsletter free of charge and without obligation and follow us on LinkedIn and YouTube!



ONLINE CATALOGUE

You can find current product and price information in our online catalogue.

Also use functions such as the product comparison, the watch list or the PDF download of article information.





MAX FRANK BUILDING
COMMON GROUND

MAX FRANK Group

Headquarters:

Max Frank GmbH & Co. KG

Mitterweg 1

94339 Leiblfing

Germany

www.maxfrank.com

