

BUILDING
COMMON GROUND

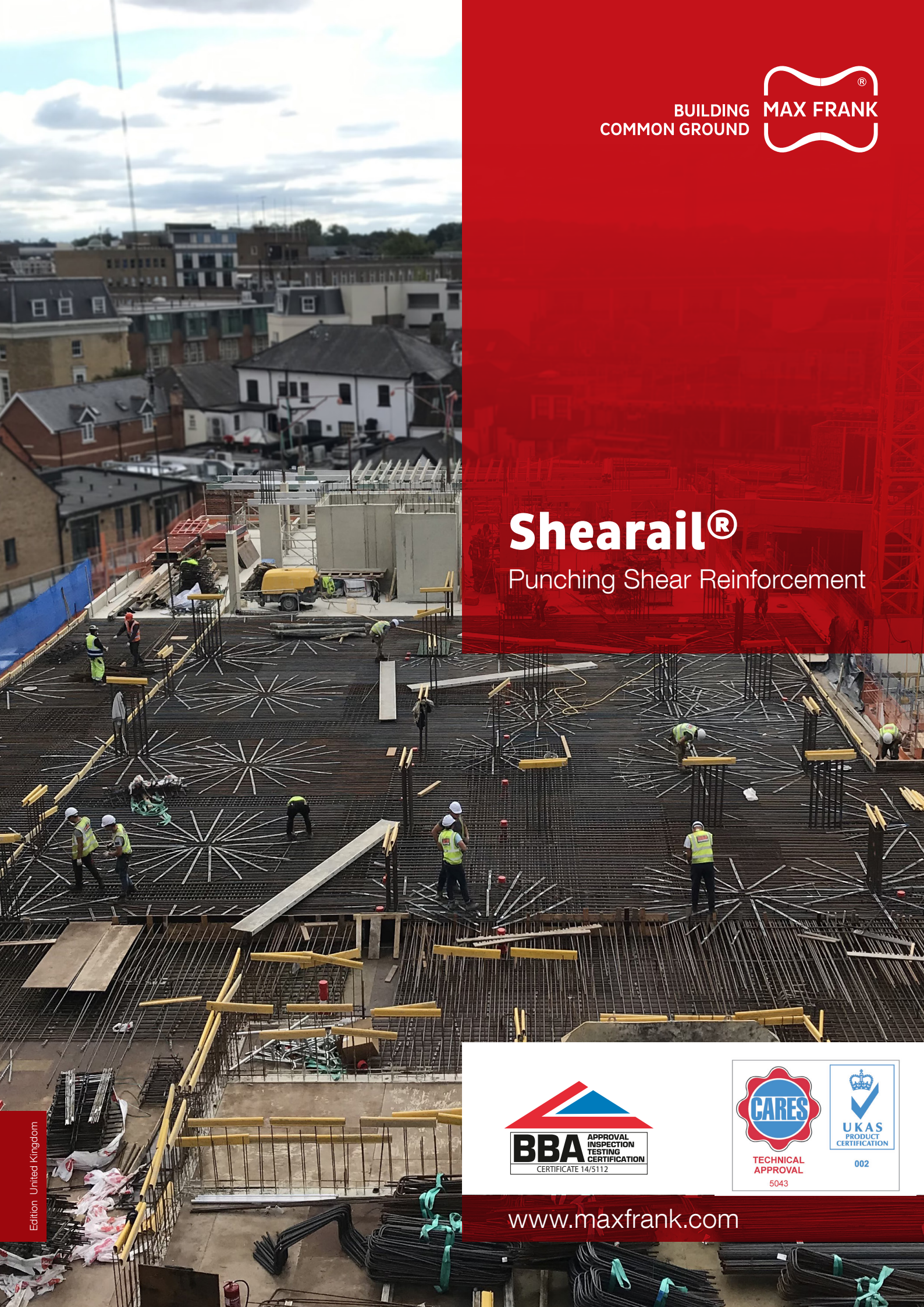

Shearail®

Punching Shear Reinforcement



Edition United Kingdom



www.maxfrank.com





BUILDING
COMMON GROUND



Shearail® is an established system and THE ONLY punching shear solution approved by both BBA & CARES.

This provides Engineers, Contractors and Local Authorities with the assurance that the material is from a traceable source and has been independently tested and verified for use in concrete floors in accordance with BS EN 1992-1-1 (EC2) & UK National Annex.

Shearail® is therefore unique to other punching shear products on the market – it provides our MAX FRANK customers with confidence about its performance and ensures peace of mind.

Shearail®

Punching Shear Reinforcement

Contents:

Application overview	4
The Shearail® system	7
System concept	8
Prefabricated studs or links?	10
Service & delivery	11
Calculation & software	12
Installation	16
Projects	17
MAX FRANK products	18
MAX FRANK services	19

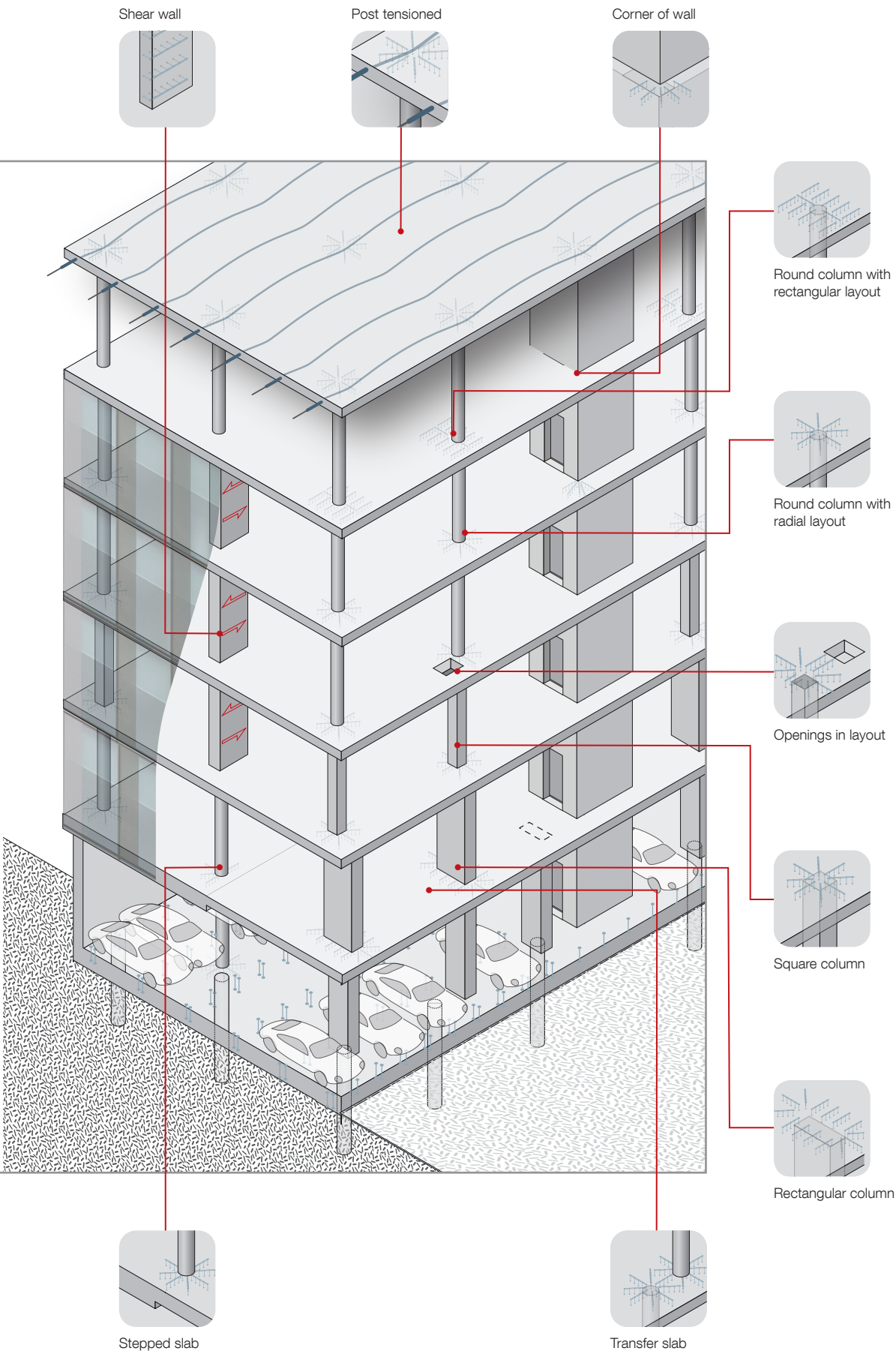

Shearail® Column Forms

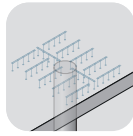

Round column



Square column

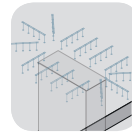

Rectangular column

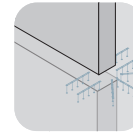

Blade column/
shear wall

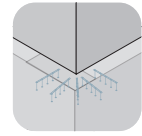

Corner of wall

Design Layouts



Column with
radial layout

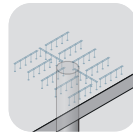

Column with
rectangular layout

Special Solutions

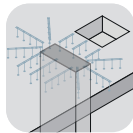

Openings in
layout



Singular stud

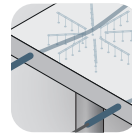

Post tensioned



MAX FRANK

BUILDING
COMMON GROUND

Shearail®



Shearail® punching shear reinforcement

The established and certified prefabricated system for concrete slabs

The weight of a concrete slab, supported directly onto a column, can result in concentrated punching shear stresses causing the slab to 'punch' through the column below. This is where CARES approved punching shear reinforcement is required.

MAX FRANK prefabricated Shearail® consists of a variable number of hot forged studs, available in a range of lengths and diameters, welded to a non-structural carrier rail. Shearail® increases the punching shear resistance of the slab and safely transfers the punching shear load from the slab to the column.

Shearail® is designed to increase construction speed, improve build quality and reduce dependency on skilled labour – significantly reducing on-site costs when compared to traditional loose links (see page 10).

As the only punching shear reinforcement with product approval by both BBA & CARES, MAX FRANK Shearail® fulfils the highest construction standards. This product provides Engineers and Contractors with confidence about its performance; Shearail® delivers assurance that the material is from a traceable source and has been independently inspected, tested and verified for use in concrete floors in accordance with the latest standards.

★ Advantages

- The ONLY punching shear solution approved by BBA & CARES
- Punching shear resistance significantly improved
- Positive end-anchorage with almost zero risk of slippage
- Fast installation saves on labour costs
- Straight-forward design & detailing
- Full compliance with EC2 & UK National Annex
- Retains the ductility of CARES B500C reinforcement bar after the forging process

Shearail® is fully supported by advanced and user-friendly design software and onsite installation support when required.

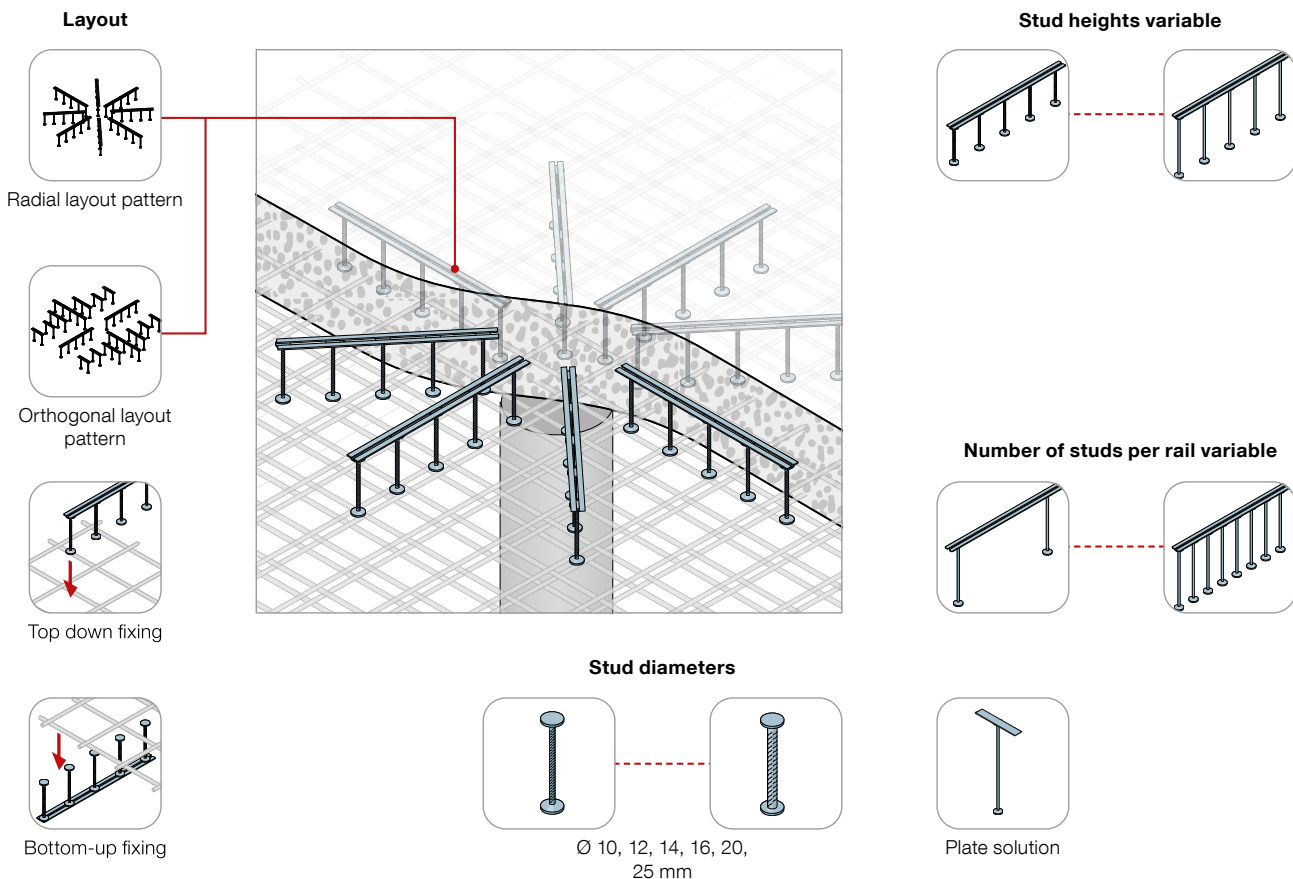

The problem: Punching shear

The loads from a concrete slab, supported directly onto a column, can result in concentrated localised punching shear stresses.

Punching shear is a brittle type failure which occurs at the flat-slab column junction. It results in the failure of reinforced concrete slabs subjected to high localised forces.

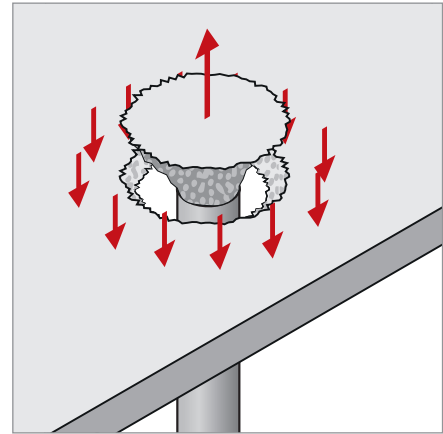

Flat slab construction

This type of construction has its advantages:

- Highly versatile; flexibility in floor layout, saving in building height
- Design flexibility; no column head drop panels required
- Overall it is fast, easy & cost-effective

However, punching shear needs to be prevented by means of reliable reinforcement.

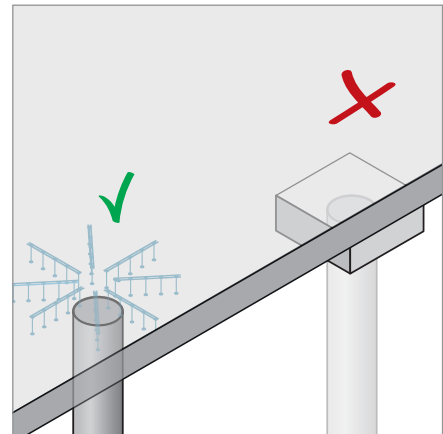

Punching shear: Solutions

There are various ways to combat punching shear - but which are the most reliable and cost-effective?

- Design larger columns or drop-down panels
- Increase effective depth
- Add more flexural reinforcement
- Use traditional, labour-intensive shear links
- Install efficient & effective double-headed shear studs; Shearail®

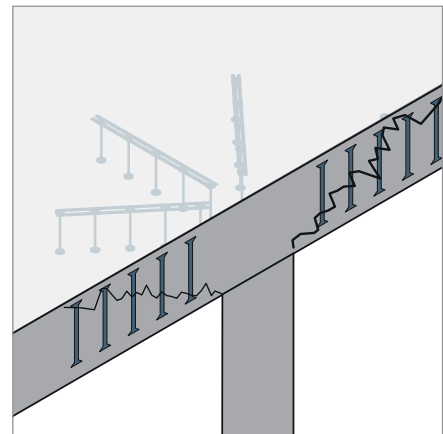

Shearail® punching shear reinforcement

Shearail® is a prefabricated punching shear reinforcement which increases the punching shear resistance of a slab and safely transfers the shear load from the slab to the column.

- As an EC2 and UK National Annex compliant system, pre-fabricated Shearail® saves on fixing time and enables easier on-site checking when compared to loose links.
- Ultimately, Shearail® increases construction speed, improves build quality and reduces dependency on skilled labour - significantly reducing onsite costs.

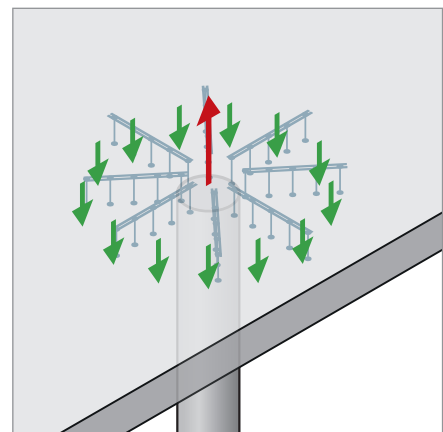

Shearail® or links

Both shear studs and links are designed to serve the same purpose – to prevent punching shear failure in flat slabs. But how does each solution perform when it comes to reliability, compliance and ease of design & installation?

In this brochure, we consider:

- The mechanical properties of each product
- Shear resistance & slippage risk
- Design & detailing
- Labour & cost implications
- Recognised industry approvals
- Compliance with national standards

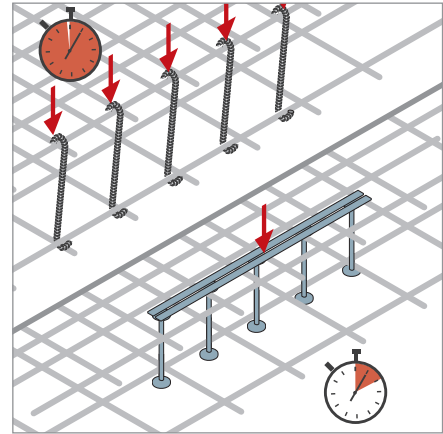

Full scale testing & accreditations

Shearail® is THE ONLY punching shear solution approved by BBA and CARES. Rigorous testing confirms that Shearail® is the logical solution which allows for up to 10 x faster installation than traditional methods i.e. links, therefore supporting the onsite time and cost savings available to the Contractor.

Shearail® provides Engineers and Contractors with assurance that the material is from a traceable source and has been independently tested and verified for use in concrete floors in accordance with EC2 and UK National Annex standards.

The MAX FRANK Shearail® is the only punching shear solution on the UK market which is approved by both: BBA and CARES



Proven Shearail® or conventional links?

It's no secret, both shear studs and links are designed to serve the same purpose – to prevent punching shear in flat slabs. But, which solution comes out on top for reliability, compliance and ease of design and installation?

The proof is in the performance...

Shearail® explained:

- BBA & CARES approved
- Shear studs welded to a non-structural twin rail at appropriate centres
- Twin rails simply hold studs in correct position – installation tolerances improved
- Prefabricated studs are placed through the planes of failure
- Creates a classic “Strut & Tie”

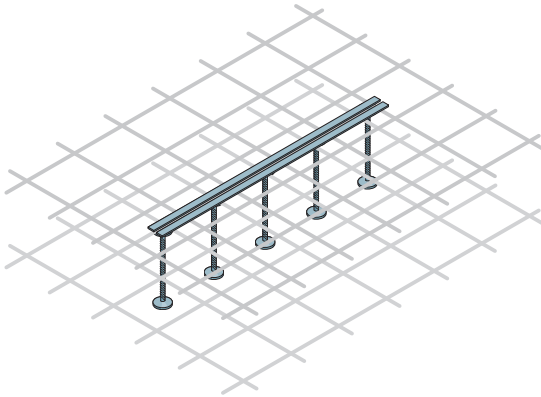

Links explained:

- Known as; reinforcement links, shear links, stirrups, ‘hook & bob’...
- Individual links are placed through the planes of failure
- Creates a classic “Strut & Tie”

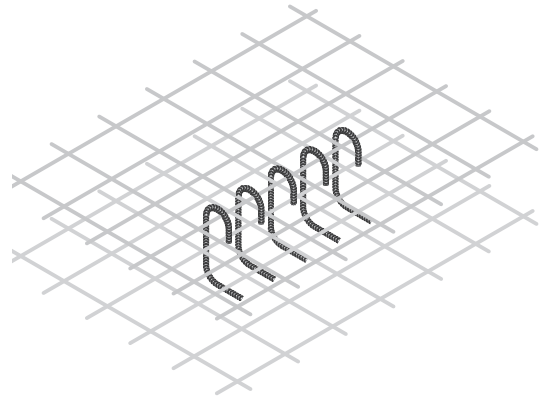

Comparison:

	Shearail®	Link
Also known as	Shear rails, studs, headed reinforcement	Hook & bob, stirrups, reinforcement/shear links
Delivered as	Prefabricated rails	Individual hooks – requiring individual positioning
Shear resistance	Significantly improved	Not significantly improved
Slippage risk	Provides positive end-anchorage with virtually zero slip	Liable to slippage under stress & yielding of links can occur – causing micro-cracking within the slab at failure
Design & detailing	Straight-forward using MAX FRANK software Design higher loads in slimmer slabs	Lengthy and manual Limits regarding the use of links in slimmer slabs
Labour & cost implication	Save on labour costs - quick installation	Labour intensive & costly; slow, difficult to install, tie & check correct positioning etc.
BBA & Cares approved?	✓	✗

“The additional material costs of prefabricated systems are generally far outweighed by savings resulting from reduced fixing time”

Best Practice Guides, European Concrete Building Project.

Service & delivery

MAX FRANK provide a full customer support service for Shearail® projects – from specification and design, through to audited manufacture from CARES approved steel, to delivery of a fully certified solution.

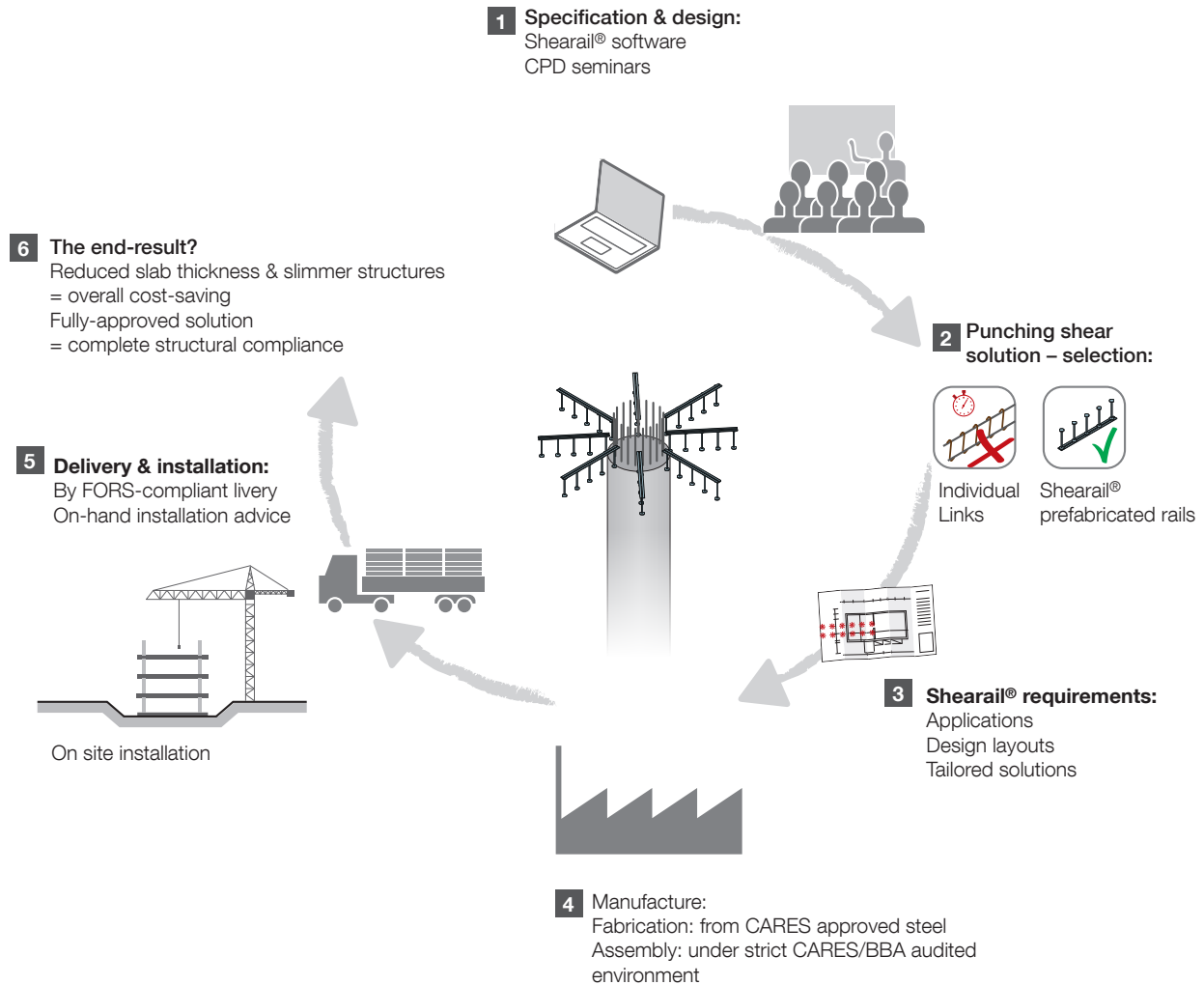

We support you

In addition to the design support MAX FRANK also provide software for clients who prefer to produce their own design calculations and layouts in-house. Our design support also enables us to accurately estimate project costs and speedily provide quotations.

On receipt of your purchase order, we will agree delivery schedules to meet your onsite programme and ensure access or time restrictions are considered. We also know that sometimes a situation on site can catch you out- if this happens, just give us a call.

MAX FRANK’s specialised project coordinators will personally keep you up to date with a stream of information regarding all stages of delivery – current, projected & completed.

Shearail® design

Punching shear design is defined in BS EN 1992-1-1:2004 (EC2) and its U.K. National Annex.

MAX FRANK has an in-depth design manual to cover most conditions encountered. For an effective and convenient design process, MAX FRANK has developed advanced software tools.

The dedicated Technical team supports engineers with complicated design cases - to provide an effective solution for engineers and contractors on site likewise.

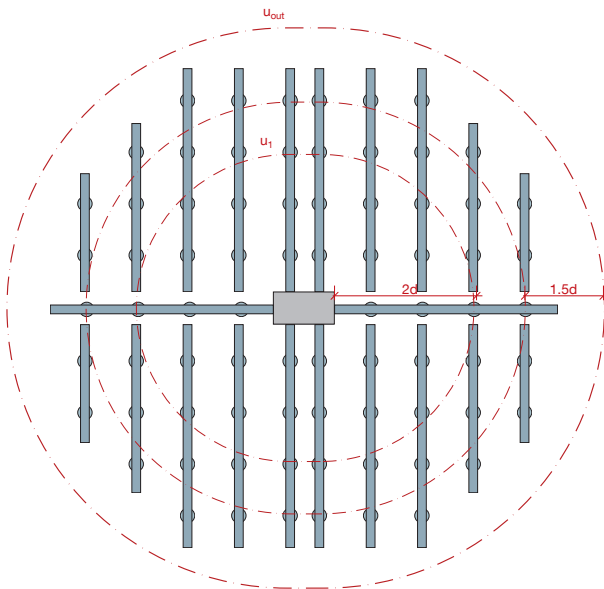

Example of orthogonal rail layout

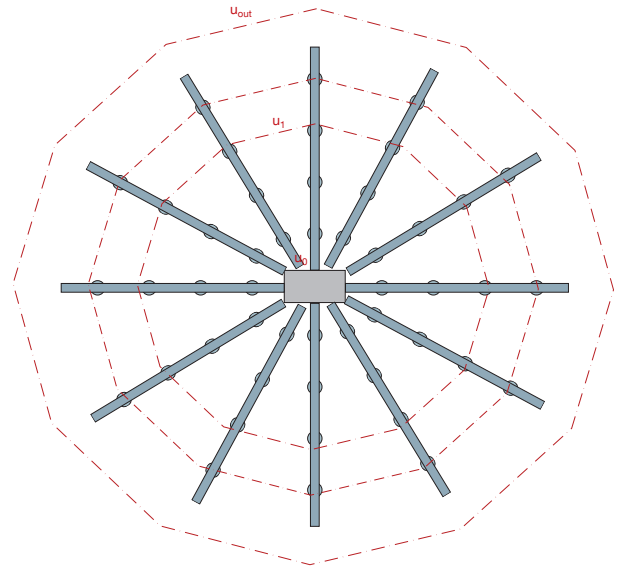

Example of radial rail layout

Outline design procedures (according to EC2)

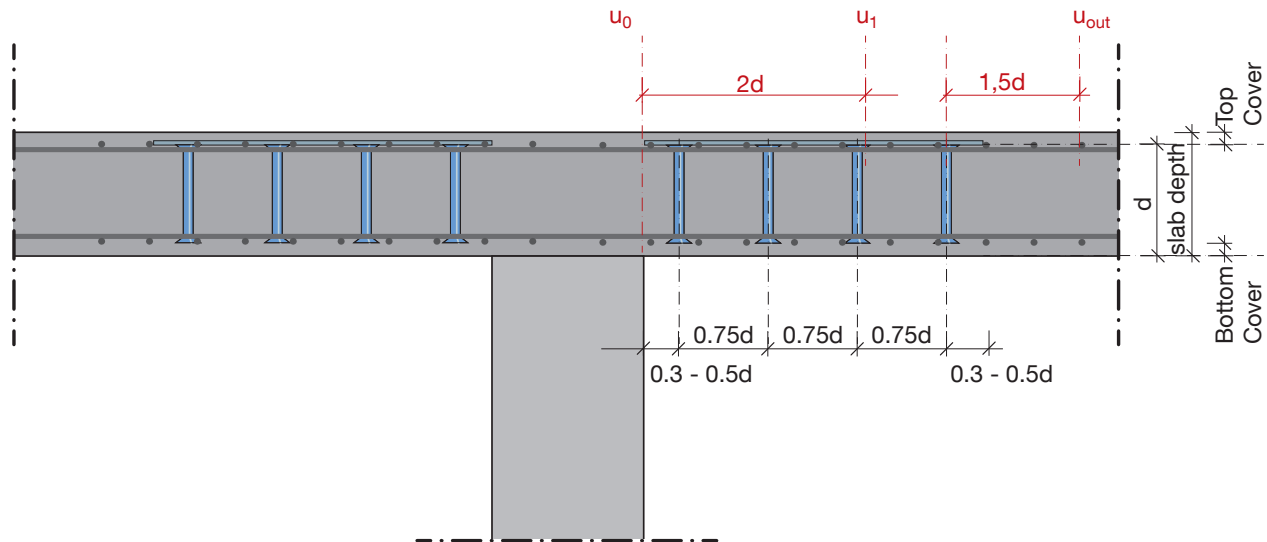

- 1** The direct shear at the edge of the loaded area (column or pile) is checked and satisfied.

$$V_{Ed\ 0} \leq V_{Rd,max}$$

u_0 perimeter must be calculated in accordance with EC2

- 2** The punching shear stress at the control perimeter u_1 is determined; if it's within punching stress resistance no punching reinforcement is required and no further action is required. However, if the limit is exceeded, punching shear reinforcement is required.

$$V_{Ed\ 1} \leq V_{Rd,c}$$

u_1 perimeter is 2d from loaded area in accordance with EC2

- 3** If the concrete stress is exceeded, additional punching shear reinforcement can be added to increase the effective resistance of the slab.

$$V_{Ed\ 1} > 2 V_{Rd,c}$$

However, it has been established from full scale tests that with Shearail® this may be increased to to 2.5 $V_{Rd,c}$

- 4** Perimeters of additional punching shear reinforcement are required to within 1.5 x the effective depth of where the normal reinforced slab is able to resist the applied shear loads (U_{out}).

$$A_{sw} = (V_{Ed\ 1} - 0.75 V_{Rd,c}) u_1 s_r / (1.5 f_{ywd,ef}) \text{ or } A_{sw,min} = (0.08 (s_r s_t) \sqrt{f_{ck}}) / 1.5 f_{yk}$$

The calculated reinforcement is projected out to within 1.5d of the u_{out} perimeter

Shearail® – advanced design software & support

Shearail® is an established CARES and BBA approved punching shear solution which has been tried, tested and trusted by engineers for many years. The reinforcement solution not only fulfils the highest standards, but it is also supported by advanced and user-friendly design software which automatically calculates the most cost-effective design solution for individual site requirements to EC2 – in accordance to the UK National Annex and national certifications

The Shearail® design software represents a huge step forward in the design and detailing of our leading BBA and CARES certified prefabricated punching shear reinforcement system.

★ Shearail® design in 5 easy steps:

1. Data input
2. Calculation
3. Saving file
4. Print out of full calculation
5. DXF file for layout

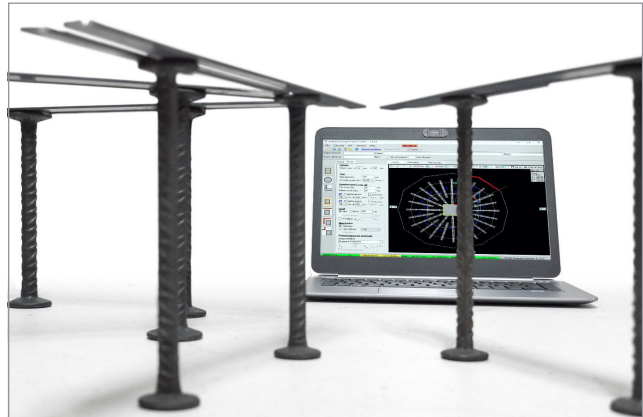

Combinations of column shapes and locations for software

Position	Geometry
Internal	Rectangular/circular
Edge	
Internal Corner	
External corner	
Wall end	Rectangular
Wall corner	

- Introducing up to 6 openings by drawing, table and percentage
- Special features including extra capacity of k_{max} and live design.

Design support required? Look no further...

Simply email your drawings to shearail@maxfrank.co.uk. Our experienced and dedicated Shearail® technical department will use their expertise to formulate the optimum concrete reinforcement strategy for your project – based on the drawings and information that you supply. Our Shearail® technical support team will provide full calculation sheets for your approval and can also supply DXFs for inclusion within your CAD drawings.

To enable us to proceed with a design we would require the following information:

- General Arrangement (G.A)/layout of the floor being considered and the floor below
- Top reinforcement drawings (bottom if transfer situation)
- Any drawings showing voids not detailed on G.A/layouts
- Any applicable sections (steps etc.)
- Shear loads (kN) and standard β factors will be used unless notified otherwise.

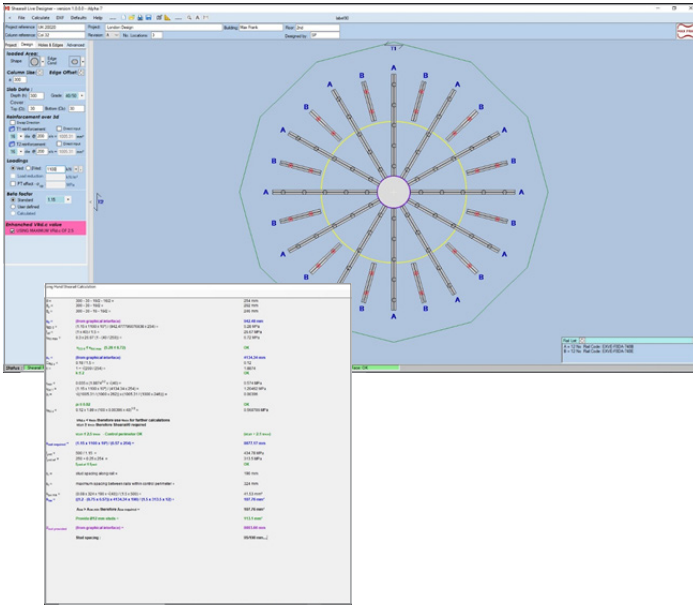

■ **Live-design**

One of the most important features of software is that the calculation is updated instantly according to graphical amendment. Therefore the software is fully interactive if the designer wishes to observe the effects of relocating voids, increasing loads or change the properties of columns and reinforcement.

■ **Graphical Interface**

The designer can input data using input tables and may use the graphical user interface to introduce openings.

Both calculation and layout will be automatically updated instantaneously when any change is introduced to the software.

■ **β-factor**

The designer can use standard factors or the output from Finite Element packages.

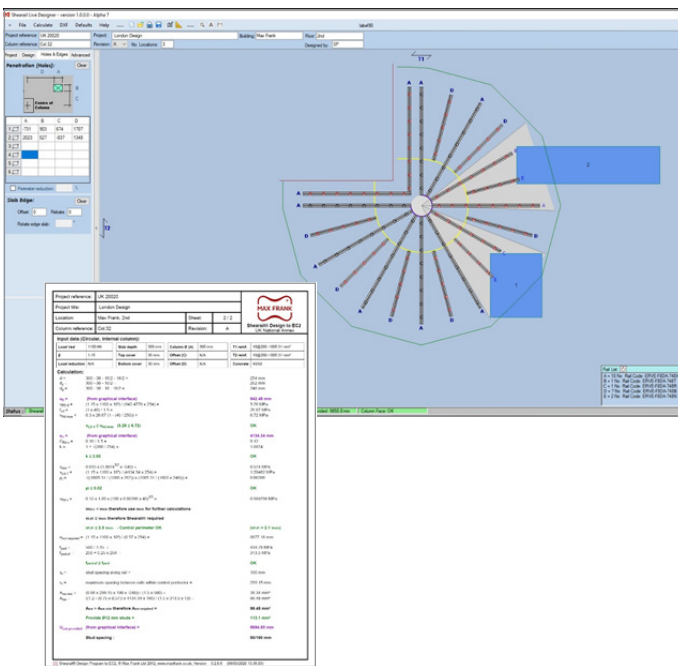

■ **'Ex' prefix**

The software has the capacity of increasing K_{max} (maximum punching shear factor) up to 2.5 in accordance to externally certified full scale testing. In this situation, the software will advise if you wish to use the extra capacity and the Shearails will be prefixed as 'EX'.

Please note that MAX FRANK Shearail® is the only product that can achieve this extra capacity.

Shearail® design software - delivering a whole raft of features

- **Intuitive graphical interface:**
 - edit layout and draw voids directly in the program – *no separate CAD required.*
 - Produce print-out based on actual layout – *no need for additional drawings.*
 - Dramatically simplified calculations – *automatically updated with any change to layout.*
- **Simple integration with your project file structure** – *save calculations to the project folder or server of your choice.*
- **Enhanced capabilities** – *add or remove calculations and projects quickly and easily.*

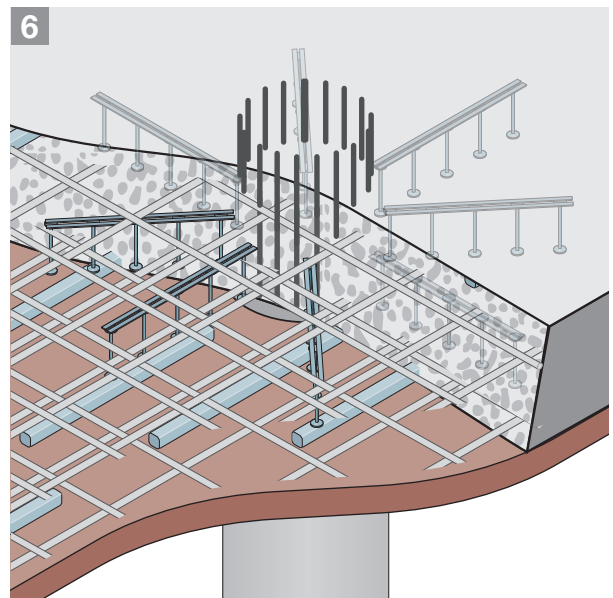
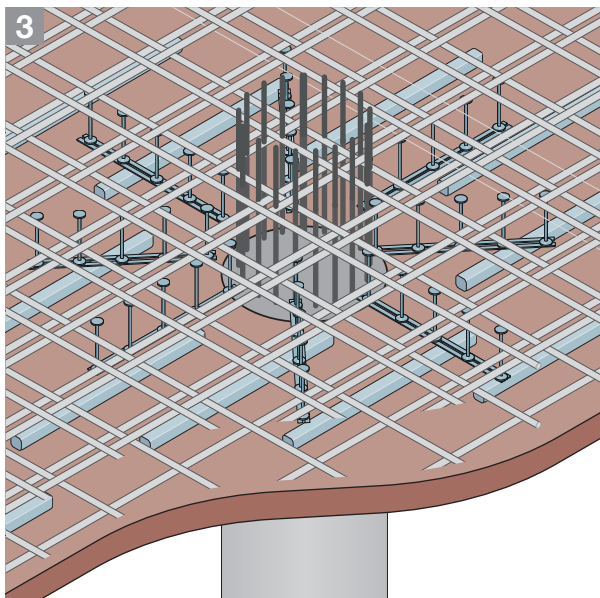
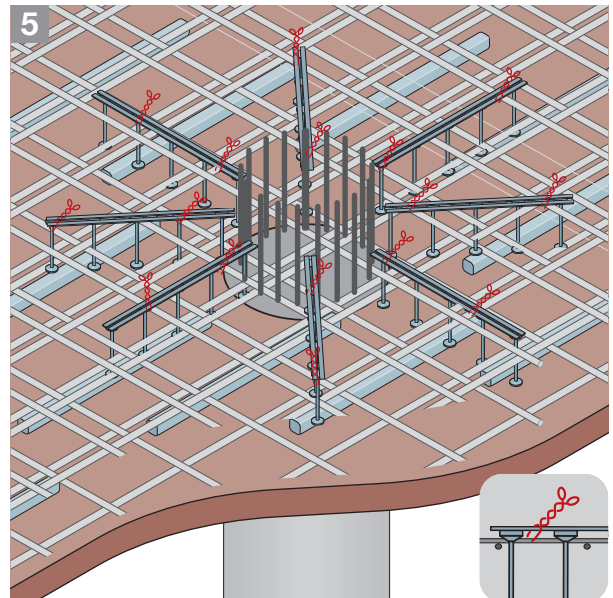
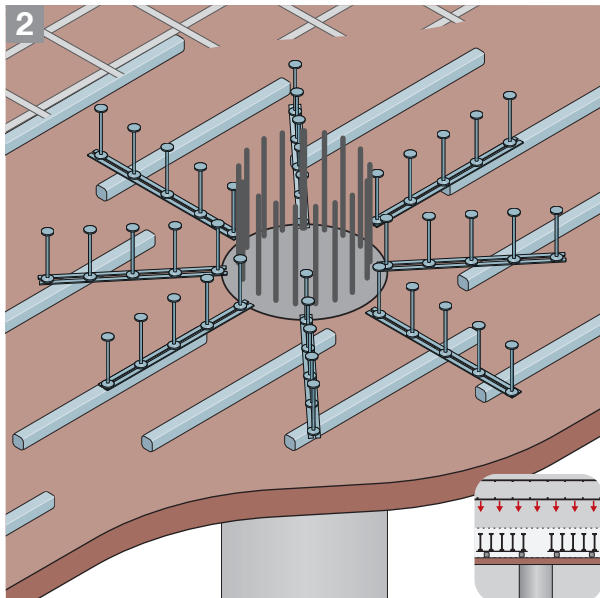
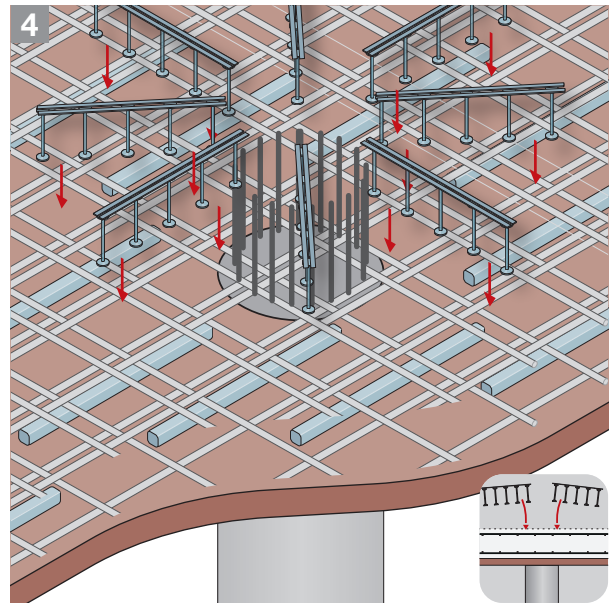
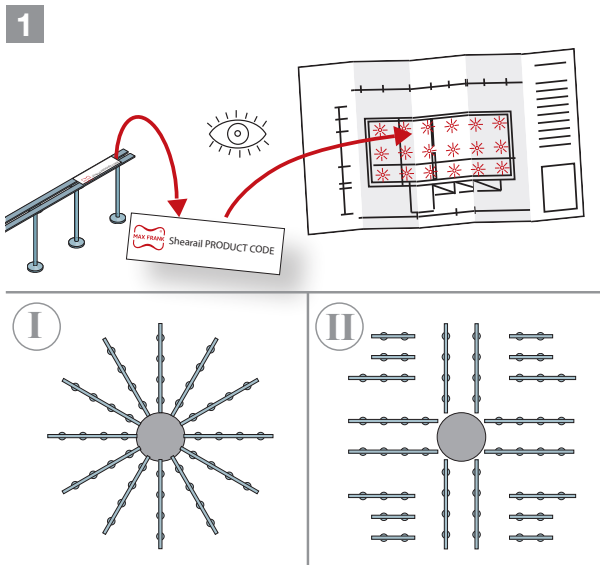



Fish Island Village, London
MAX FRANK system: Shearail®



Nine Elms redevelopment, London
Products: Shearail®



Richmond upon Thames College, London
Products: Shearail®



University of Surrey, Block R, Surrey
Products: Shearail®, Egcoibox®



Royal Albert Basin: Great Eastern Quays, London
Products: Shearail®, Egcodorn®



Royal Albert Wharf: Gallions Quarter, London
Products: Shearail®, Stremaform®



Kings Crescent Estate, London
Products: Shearail®, Egcoibox®, Egcodorn® & Egcodubel



Greenwich Square, London
Products: Shearail®

Egcoibox® thermal break balcony connectors

Minimise thermal bridging by creating a thermal break between an external component and an internal component, reducing condensation and mould formation. Egcoibox® BBA approved thermal break connectors feature mineral wool insulation to fire rating REI 120 and conform to the amended Building Regulations 7(2) for combustible products for England. Our design software package available to download. Covered under a separate BBA certificate 16/5345

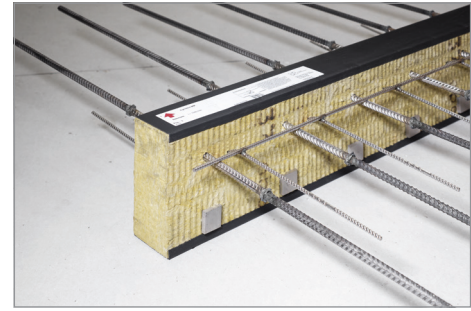

Pecavoid® ground heave solution

Combat the effects of ground heave on foundations with BBA approved Pecavoid® cellular void former. Compatible with the original tried & tested Pecafil® permanent formwork, MAX FRANK groundwork solutions complement each other whilst fulfilling the highest standards.

Visit our website to trial our time-saving calculation tool!
Covered under a separate BBA certificate 12/4923

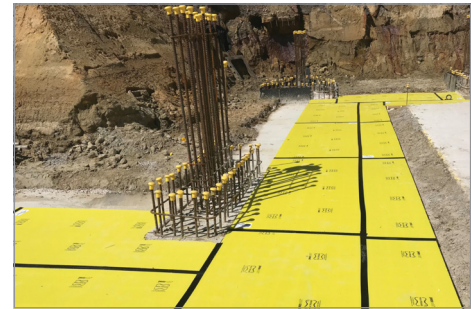

Egcodorn® shear dowels

Expansion joints are created in concrete structures to decouple sections and avoid stress cracks. Prefabricated Egcodorn® shear connectors offer simplified transmission of shear forces which occur in such joints. The engineered 'anchor' design of Egcodorn allows safe & controlled transmission of very high loads. This product is not covered by a BBA certificate.

MAX FRANK shear dowels for various applications:

- Egcodorn® - practical solution for high static loads
- Egcodorn® DND - optimal solution for dynamic stresses
- Egcodubel® - economical solution for small/medium loads
- Egcopal- sound insulated solution

This product is not covered by a BBA certificate.



Stremaform® permanent formwork for day joints

The Stremaform® permanent "self-supporting" formwork system eliminates the need for props, formwork removal and scabbling of the concrete surface when constructing:

- Practical day joints
- Deep slabs & bases
- Expansion joints with shear dowels

Suitable for slabs & bases of various concrete depths, Stremaform® enables Contractors to complete a sequence of concrete pours, whilst attaining an established bond throughout the joint – ultimately reducing the overall construction period. It can even be tailored to incorporate waterstops, crack-inducing elements and shear dowels for transverse forces and dynamic loads.

This product is not covered by a BBA certificate.



VISIT OUR WEBSITE

www.maxfrank.com

Our website offers information regarding our engineered products and a wide range of services to support you through every design and construction phase.

Many of our solutions are project or application specific. Virtually all of our products and systems can be customised, and yet retain the ability to be used together.

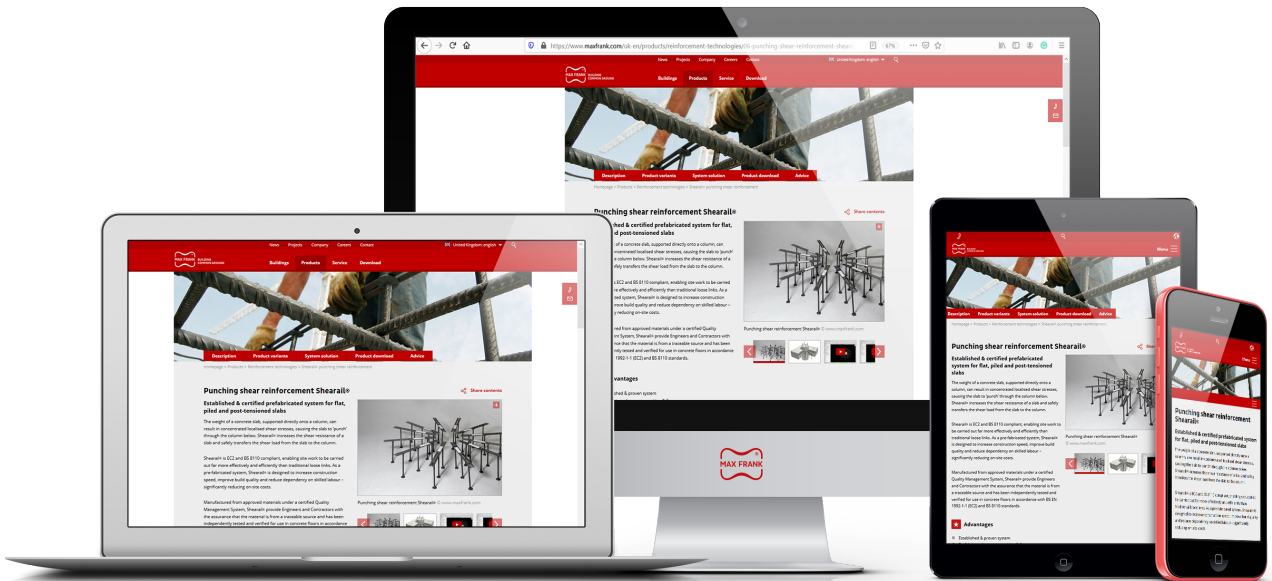

DESIGN SOFTWARE: SHEARAIL®

Automatically calculate the most cost-effective punching shear reinforcement design solution using MAX FRANK's advanced software. Features include; creation of multiple voids around a column & edge design for multiple situations.

User-friendly & graphical design in 5 easy steps:

Data input | Calculation | Saving | Printing | DXF output



Download & register from:

www.maxfrank.co.uk/shearail-software

CPD SEMINAR & DESIGN WORKSHOP

Punching Shear Reinforcement "An Effective Solution"

Punching shear failure is a catastrophic brittle type failure which occurs at the flat slab-column junction. This presentation covers the problem of columns "punching" through the slab above and how to overcome the problem with an introduction of design software to EC2 standards.



MAX FRANK BUILDING
COMMON GROUND

Max Frank Ltd.

Clough Street, Hanley
Stoke-on-Trent
Staffordshire, ST1 4AF

Tel. +44 (0)1782 598041

info@maxfrank.co.uk
www.maxfrank.com