

BUILDING
COMMON GROUND



Zemdrain®

Controlled permeability
formliner



Photo: Bernhard Strauss, Freiburg



BUILDING
COMMON GROUND



Zemdrain®

Controlled permeability formliner

Contents

Why use Zemdrain®	4
How it works	6
Product Overview	8
Fields of Application	10
Benefits for Concrete Durability	11
Drinking Water Reservoirs	12
Wastewater & Sewage Treatment Plants	14
Marine & Waterways Structures	16
Dams, Locks and Power Stations	18
Transport Infrastructure	20
Exposed Concrete	22
Technical Details	25
Test Reports	30
Additional Products	31



Service life and sustainability of concrete structures

Concrete structures are normally designed for a service life of 50 to 100 years, with a longer life for some special structures. Structures, which are exposed to atmospheric pollution, may need to be refurbished several times during their working life. This need for refurbishment arises due to the poor quality and permeability of the surface concrete.

A slight increase in investment costs at the construction stage can enormously reduce potential future refurbishment costs or even avoid them completely. Tests carried out at several wastewater treatment plants may serve as an example. Test results prove that no refurbishment costs at all are to be expected within a time period of 50 years when using the permeable formliner Zemdrain®, whereas concrete surfaces produced without Zemdrain® show visible degradation already after only 10 years, which means that at least two refurbishments will be necessary during their service life. Potential savings would thus amount to more than 200 € per square meter of wall surface (refer to chart).

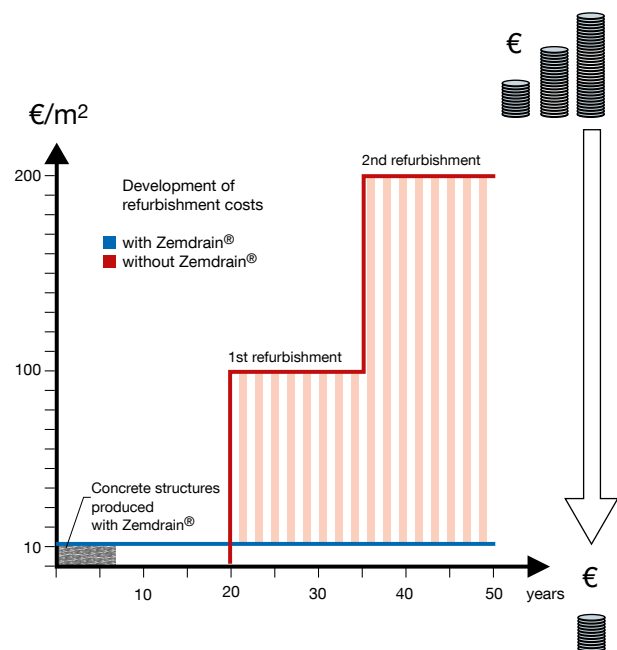

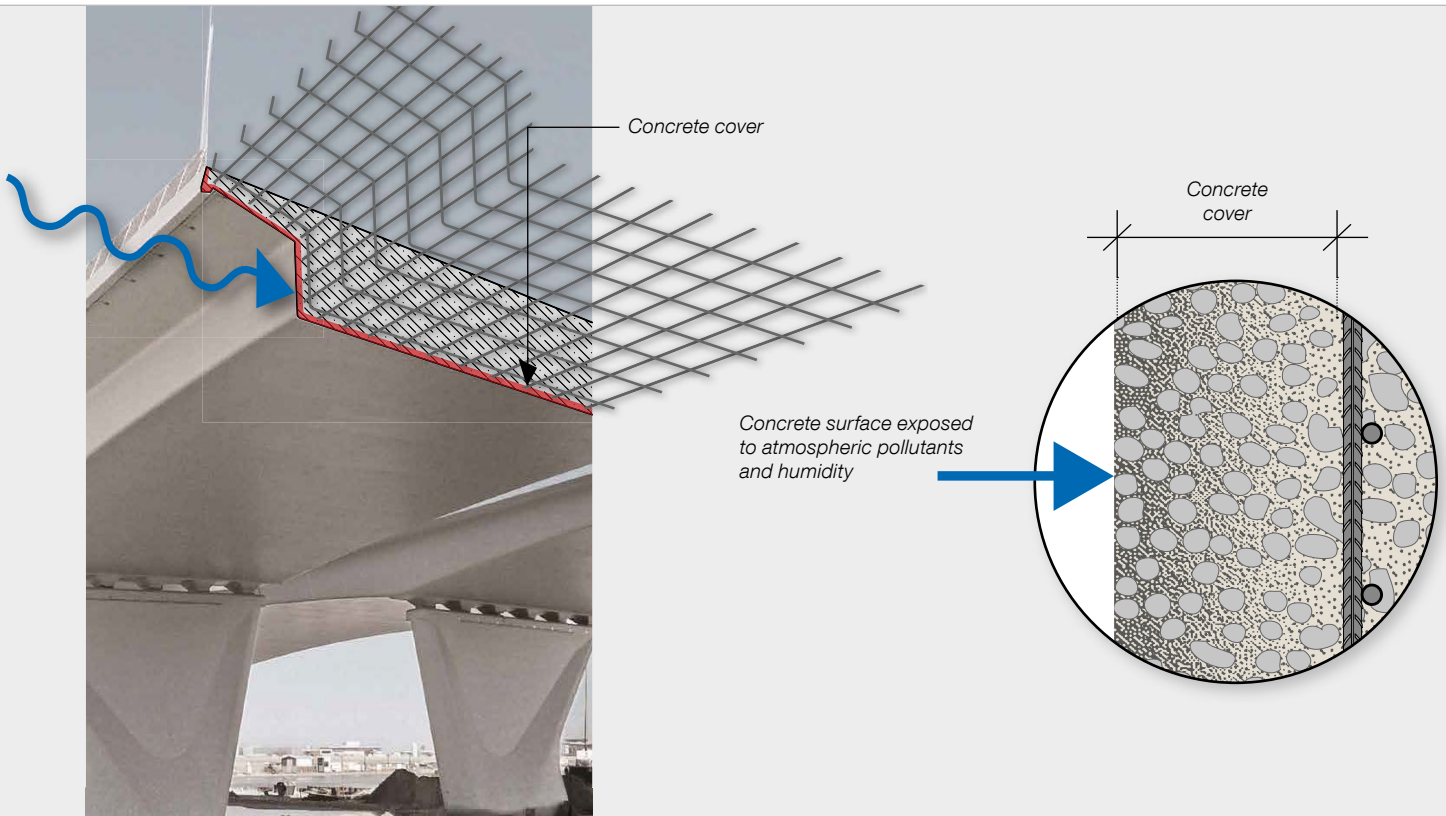

High-quality concrete surfaces

Concrete cover (the zone between reinforcement and concrete surface) protects reinforcement against aggressive environmental elements.

Cover concrete must be as dense and as hard as possible to prevent surface degradation and the ingress of aggressive elements to the reinforcement. Bridges, for example, are exposed to these aggressive elements: oxygen, carbon dioxide, humidity, wind, sand and mineral salts.

Due to the poor quality of concrete surfaces, visible damage to the concrete can occur after only a few years. The use of Zemdrain® modifies the surface characteristics of the concrete which considerably improves all concrete properties increasing quality and durability.



without Zemdrain®

with Zemdrain®

High-quality concrete

SPACERS
EXTRUDED FIBRE CONCRETE

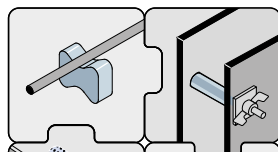

DISTANCE TUBES
EXTRUDED FIBRE CONCRETE

ZEMDRAIN®
CPF FORMWORK LINER

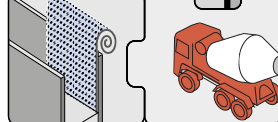

CONCRETE
QUALITY

Principles of use

Zemdrain® controlled permeability formliners (CPF) considerably improve the quality of the concrete surfaces of vertical and inclined walls.

- 1** Zemdrain® is fixed to the formwork before erection (see separate Installation Guideline).
- 2** Once the formwork is erected, concrete is placed and compacted in accordance with normal practice.
- 3** Zemdrain® retains the concrete fines whilst allowing the controlled drainage of excess air and water that is normally trapped at the concrete/formwork interface. Additionally, water retained within the formwork side of the formliner is given back to the concrete during the curing phase (early age curing of green concrete).
- 4** After removal of the formwork, the very dense, hard, virtually blowhole free surface uncontaminated by release agents produced with Zemdrain® is immediately visible.
- 5** Use of Zemdrain® optimises the surface water/cement ratio, minimises blowholes and improves early age curing to give a high quality durable concrete surface with optimum resistance to all forms of environmental attack.

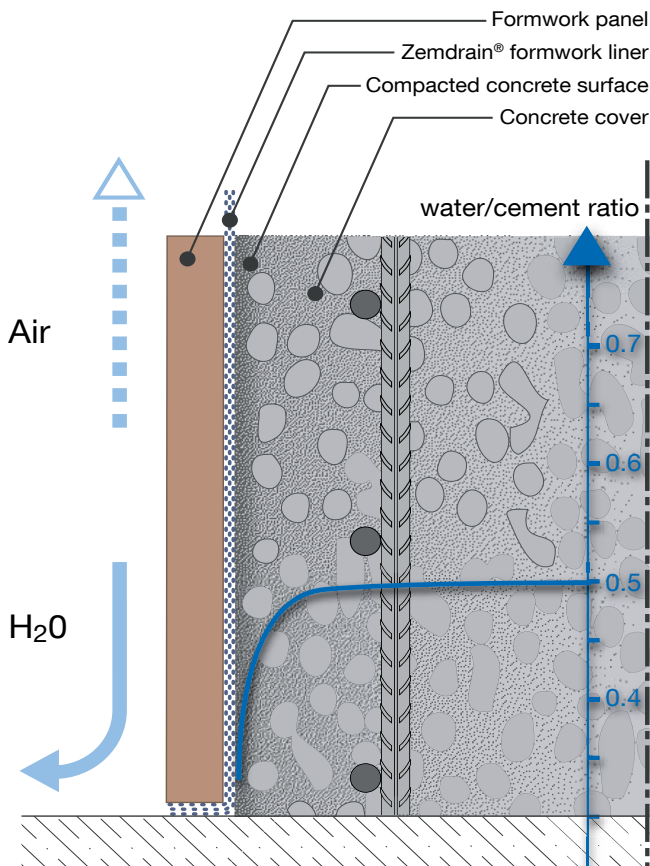

Use of Zemdrain® reduces the water/cement ratio in the outer surface zone

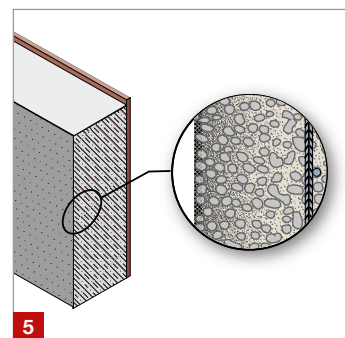
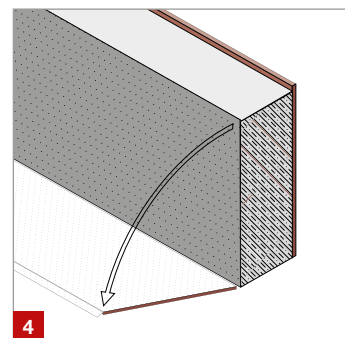
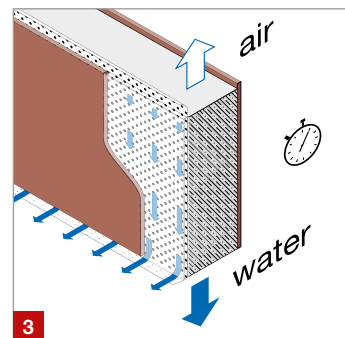
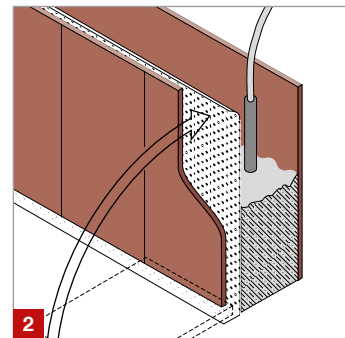
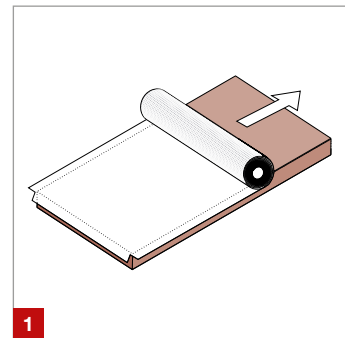

Broken concrete edges reveal the benefits of using Zemdrain®.

The low water/cement ratio, virtually blowhole free concrete surface produced by Zemdrain® is uncontaminated by release agent residues.

Thus, the concrete has an increased service life expectancy with reduced maintenance requirements.

The following applies in general:

Dark concrete – low water/cement ratio

Light concrete – high water/cement ratio

Tubbox® column formers
blowhole free with
Zemdrain®

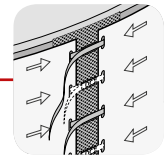
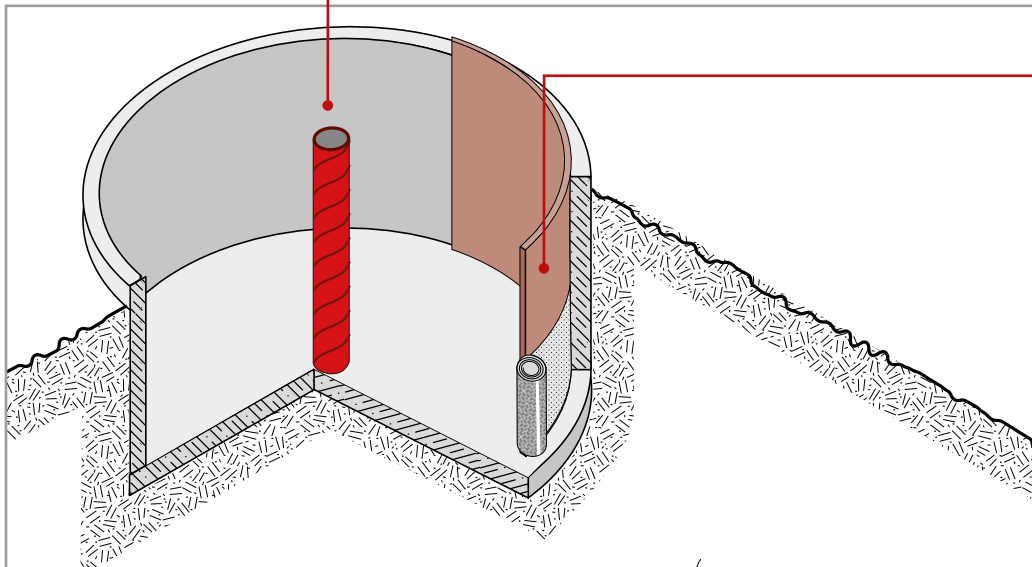

Zemdrain® Classic
prefabricated

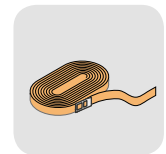

Tensuring belt

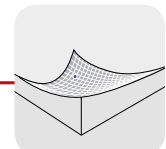
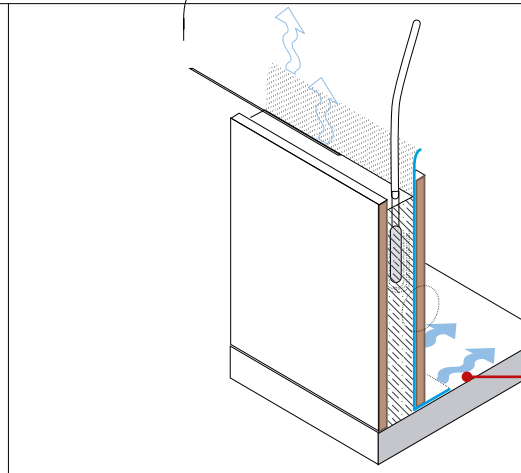
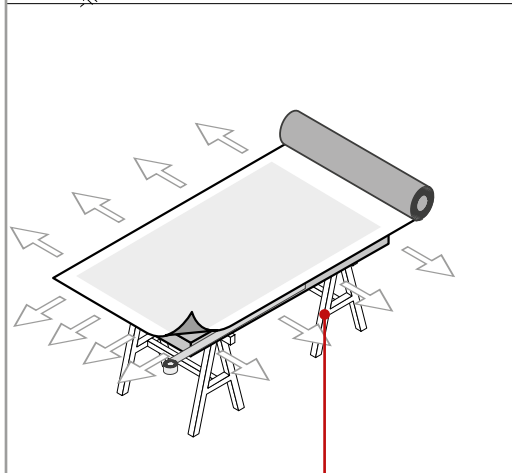

Zemdrain® MD

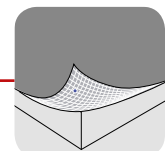

Zemdrain® Classic

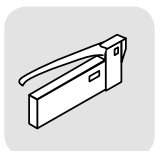

Stapler

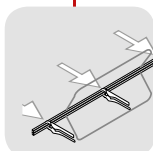

Tensuring clamp MD



Tensuring clamp

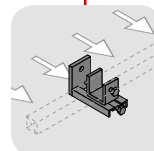

Tensuring device



Adhesive tape

Zemdrain® Types

There are three types of Zemdrain®: Zemdrain® Classic, Zemdrain® Classic prefabricated and Zemdrain® MD. All three types of Zemdrain® produce concrete of equal quality

and durability (depending on the used concrete) – however, the technical use and the application of the liner onto the various formwork systems are different.

Zemdrain® Classic

A single use liner

- Smooth or slightly textured, grey upper surface (concrete side)
- Rear side (formwork side) black and rhomb shaped recesses
- Roll size: 1.6 m – 4.2 m width and 50 m length
- For covering large surfaces
- For single use
- For special applications, e.g. when round steel formwork is used in monolithic construction

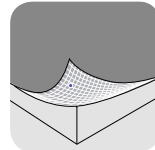

Zemdrain® Classic



Zemdrain® Classic prefabricated

Zemdrain® Classic prefabricated is a tailor-made liner for lining the inner convex surface of special pre-assembled circular tank forms. The product is delivered prefabricated to the construction site. Prefabrication off-site helps to create a lining for circular steel and/or wooden formwork which reduces the risk of fold formation.

- Form heights ≤ 4.00 m can be lined using only one prefabricated sheet.
- Form heights > 4.00 m are lined using two prefabricated sheets which are overlapped.
- For single use.
- Zemdrain® Classic prefabricated is supplied with a special fleece part with loops, as well as the main prefabricated liner and a cover liner.

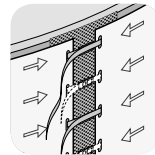

Zemdrain® Classic prefabricated



Zemdrain® MD

A multi use liner (2 to 3 uses possible)

- Smooth to slightly textured, white surface (concrete side)
- Rear side (formwork side) with special draining grid
- Roll dimensions: Width 2.5 m and length 35 m
- Very economic because of the possibility of repeated use (2 – 3 times), simple and quick assembly
- High water storage capacity, therefore also suited for inclined or horizontal surfaces

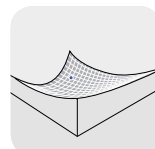

Zemdrain® MD



More than 20 years of experience with Zemdrain®

Zemdrain® controlled permeability formliners have been used for many years in thousands of projects worldwide. In the Gulf region, for example, maximum durability and low maintenance costs under extreme environmental influences are of paramount importance. Very high levels of airborne salts, excessive air humidity and regular sandstorms are extreme challenges for any concrete structure. To ensure the highest quality concrete surfaces and maximum durability resistance, the use of Zemdrain® is highly recommended.

Concrete structures must fulfil extremely high quality requirements not only in the Gulf region, but also in other hazardous environments like wastewater treatment plants. Zemdrain® is widely used for improving surfaces of these structures. Concrete must be resistant against hydro abrasion and sufficiently protected against the attacks of chemicals, acid and water. Only a high-quality surface concrete zone prevents premature degradation by abrasion or frost and thus increases the maintenance free life of these structures.

As surfaces are uncontaminated by release agent residues, microbiological growth is also minimised and surfaces are easy to clean.

Applications of Zemdrain®

Zemdrain® of all types consists of a filter layer consisting of polypropylene fibres with a highly controlled pore structure that ensures retention of cement and fine aggregate but is permeable to water and air. Adhesion of the filter to the concrete is minimal. The rear of the liner is a drainage layer consisting of either polypropylene fibres or a special grid.

Zemdrain® is widely used for various applications:

- Drinking Water Structures
- Wastewater & Sewage Treatment Plants
- Marine & Waterways Structures
- Dams & Power Stations
- Transport Infrastructure
- Exposed concrete



Wastewater Treatment Plant, Munich (D), 1990



North Meadowvale Reservoir and Pump Station, Ontario (CA), 2006



Pumping Station, Gold Coast (AUS), 2007



Grignac Bridge (FR), 2007



Al Garhoud Bridge, Dubai (U.A.E.), 2007



Water reservoir, Trin (CH), 2008



Water Treatment Plant, Essen (D), 2011



Road of the Future, Oss (NL), 2013

A low water/cement ratio, reduced to match the hydration requirements in the concrete surface next to the formwork and a compact concrete structure make the surface concrete dense and hard. Additionally Zemdrain® retains part of the water, which is transported back to the concrete surface during the early age hardening phase (curing of green concrete).

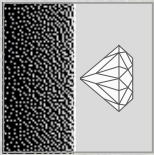

Significantly increased surface hardness and abrasion resistance.

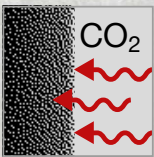

The dense surface with a reduced water/cement ratio significantly reduces the rate of carbonation.

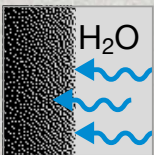

The increased cement content at the surface, together with early-age curing help reduce surface permeability and reduce water absorption.



The dense surface concrete gives increased freeze/thaw resistance.

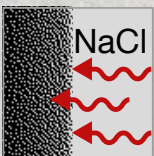

Reduced surface porosity minimises chloride ingress.

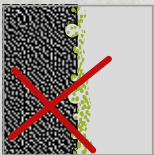

The uncontaminated, virtually blowhole and blemish free surfaces reduce the potential for the growth of micro organisms. Drinking water reservoirs made from concrete without the use of release agents guarantees hygienic drinking water.

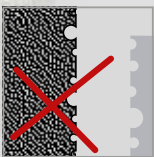

The percentage of blowholes and pores is not only reduced on the concrete surface, but also immediately below. This provides additional safety for applications in drinking water reservoirs or for the use of coatings.

Use of Zemdrain® for Drinking Water Reservoirs

The preservation of a high drinking water quality is very important. Asset owners require that their water tanks are watertight, long lasting and maintain water cleanliness.

Using Zemdrain® helps ensure that all three requirements are met and that the water quality does not change during storage.

Tests on structures in service for over 15 years have proven that Zemdrain® cast surfaces remain in excellent condition, with no signs of degradation or growth of micro organisms (for more information please refer to Page 29).

By using Zemdrain®

- the virtually blowhole free, low porosity concrete surface is very watertight;
- the low water /cement ratio surface is resistant to attack from water and airborne agents;
- surfaces are uncontaminated by release agent residues thus avoiding harmful growth of micro organisms
- asset owners profit from an excellent economic efficiency of structures, because of reduced maintenance and cleaning costs and the avoidance of coatings.

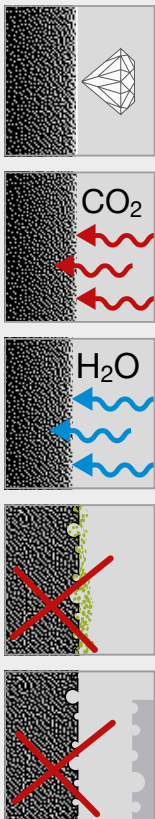

Refer to page 11

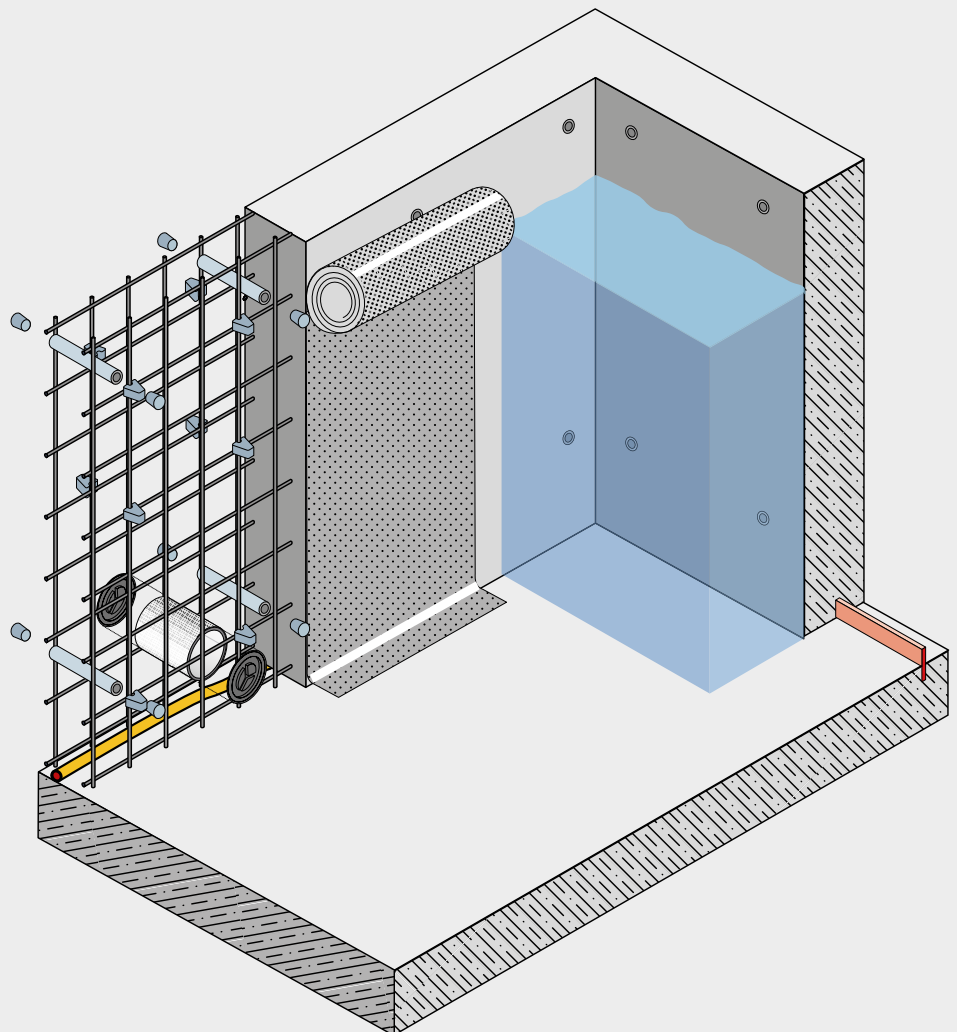

Potable Water Reservoir Raestrup – Telgte, Germany

In February 2010, the professional water association Telgte started construction of a new drinking water reservoir.

In addition to a low porosity, blowhole free surface concrete for the lateral walls, a KTW* approval for the use in the drinking water/food industry was required for all products used. These high requirements were perfectly met by using Zemdrain® MD and additional FRANK products with KTW approval.

**KTW – approval authority for products used in drinking water structures*



Water Filtration Plant, London, Ontario, Canada

The South East Terminal project covering the supply of a water filtration plant comprises a new water tank with a capacity of 25 million litres and a pump station. Construction of the project started in 2010.

Zemdrain® MD is used on both sides of the concrete walls with excellent results. The dense, blowhole free concrete surface is extremely important for climatic zones with extreme temperature variations and where the concrete is exposed to freeze/thaw attack.



Refurbishment Reservoirs Schwarzer Berg, Leipzig, Germany

From July 2007 to October 2009 a new mixed water line in the quarter Leipzig-Mocker was installed as a culvert underneath the road. This water line transports drinking water from the drinking water reservoirs Schwarz Berg near Touché to the northern residential quarters of Leipzig. The concrete surface of the drinking water reservoirs had to be free from chemicals and non porous, in order to prevent the growth of micro organisms, fungi and algae. Contractors fulfilled these high requirements and created an improved concrete surface quality by using Zemdrain®.



Use of Zemdrain® for Wastewater & Sewage treatment plants

Acid is very aggressive to concrete and one of the best forms of protection is a dense and cement rich surface. This type of surface also resists abrasion from particulates in the water.

The use of Zemdrain® ensures a surface that meets these requirements:

- By increasing the cement content of the outer 20 mm of the surface by in excess of 75 kg/m³
- By increasing surface density and thus increasing the tensile strength

By using an optimum concrete composition and Zemdrain® it is possible to produce tanks that can be exposed to strong acid attack without additional coating.

Tests on structures in service for over 10 years have proven that Zemdrain® cast surfaces remain in excellent condition, so that the concrete service life is considerably extended (for more information please refer to page 28).

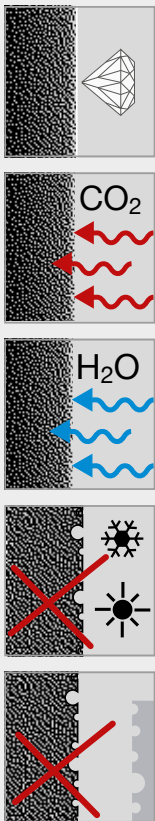

Refer to page 11

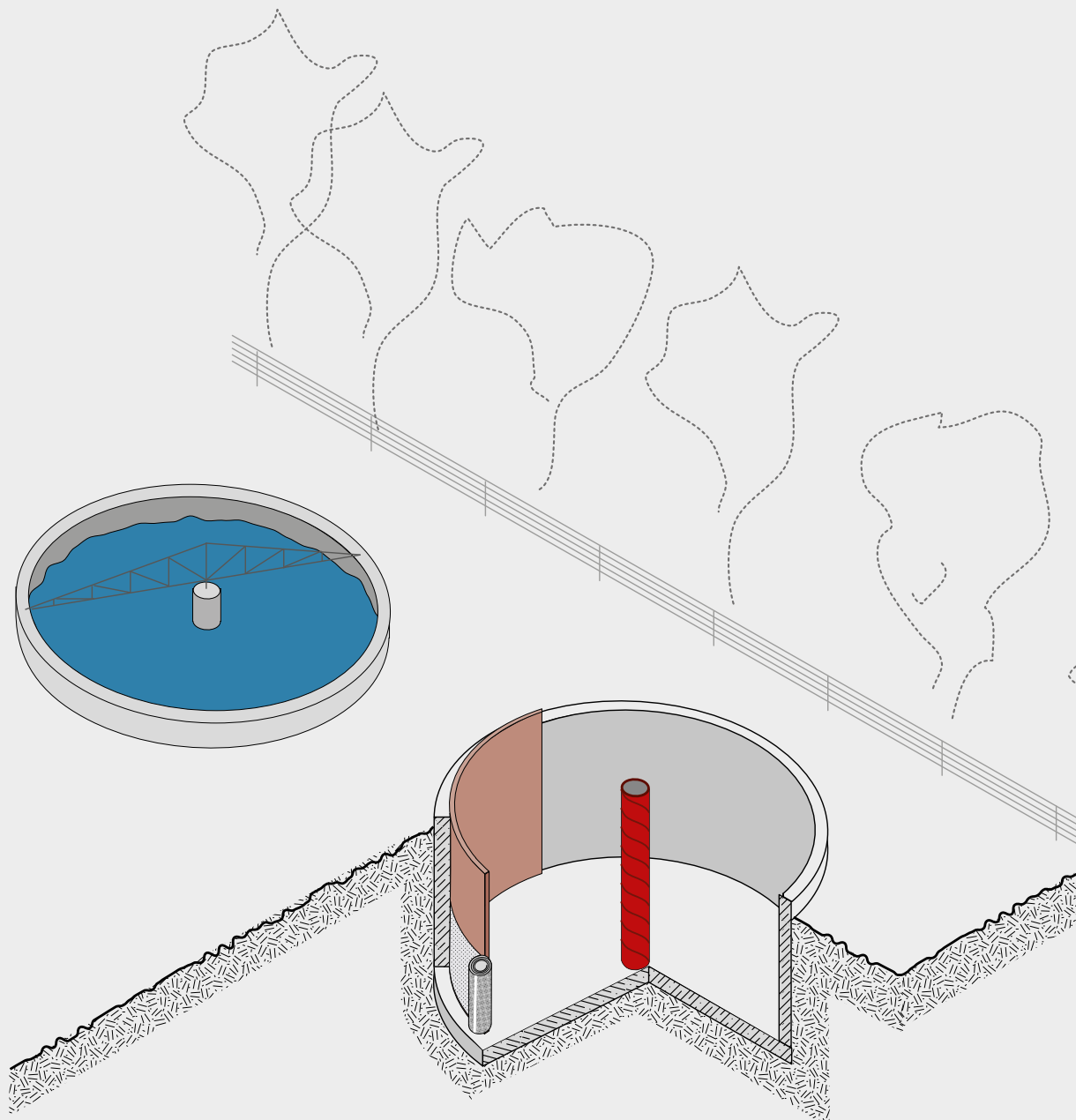

Retention basin for Wastewater Treatment Plant Seiferts, Germany

A new circular basin used as a buffer reservoir was erected in the wastewater treatment plant at Seiferts. Water storage volume of the basin with a diameter of approximately 15 m is 240m³.

Tough specification requirements included that the surface must be non porous to prevent penetration of micro organisms, that no chemicals must be used and the surface must be dense and impermeable, in order to withstand continuous water movements and cleaning with a pressure washer. Zemdrain[®] use was required to help meet all the requirements.



Wastewater Treatment Plant Henriksdal, Stockholm, Sweden

Serving the city of Stockholm, this is one of the largest and most modern underground treatment plants in Europe. Originally opened in 1941 the plant has been continuously upgraded with extended chemical and biological treatment facilities. As part of the current upgrade, Zemdrain[®] MD has been used on the internal faces of all chambers.



Sludge Tanks, Clench Wharton STW, Norfolk, England

On the banks of the Wash near King's Lynn, a new bio-solids treatment centre has been constructed. The project consisted of the construction of two 20m high circular tanks with a 20m diameter. In these tanks the internal upper surfaces are subject to exposure to very strong acid attack. To offer protection to the concrete, the upper 5.0m of the surfaces of the curved tank walls were cast using Zemdrain[®] MD. For the domed roof, Zemdrain[®] Classic was used to give the same high quality dense low porosity concrete surface.



Use of Zemdrain® for Marine & Waterways Structures

Sea walls, harbours, locks, canals, container terminals, etc. are all placed under attack by wave action and salt laden water. By improving concrete durability the maintenance free life of all of these structures can be increased significantly. Using Zemdrain® ensures that the concrete surface is the best that it can be to resist aggressive elements.

- Use of the Zemdrain® formwork liner delays the rate of chloride ingress thus extending the potential life of any structure irrespective of the cement type used.
- The early age curing benefits of Zemdrain® resulting in increased tensile strength of the concrete surface ensuring that the abrasion resistance of surfaces is also enhanced.

Tests on sea wall structures in operation for over 6 years have shown that compared to non-CPF cast surfaces, Zemdrain® cast surfaces show much reduced rates of chloride ingress and carbonation with significantly increased surface strength (for more information please refer to page 27).

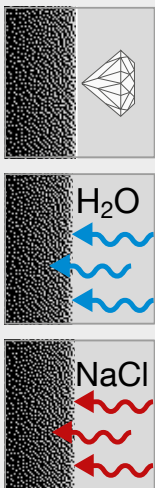

Refer to page 11

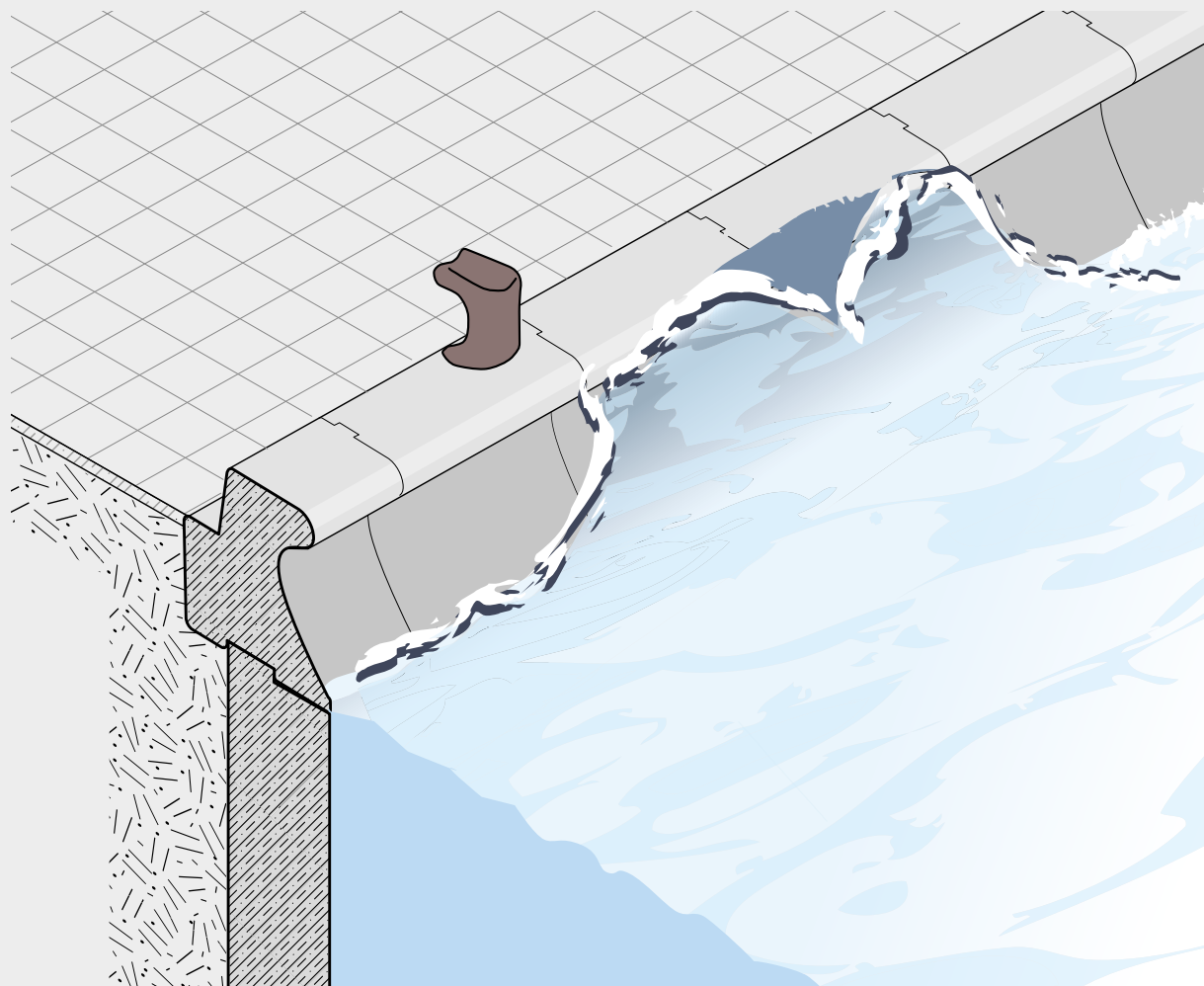

Harbour/Breakwater, Rurutu, French Polynesia

As a result of significant degradation due to the onerous marine environment in the region the existing main dock had to be demolished and reconstructed. In view of the harsh and aggressive salt water conditions combined with the use of locally won mix constituents, it was decided to use the controlled permeability formliner Zemdrain® to provide a better finish and to reduce surface porosity of the concrete to a minimum. The liner also aided the curing process of the concrete which is very important for such environments.



Wave return units, Doha Corniche, Doha, Qatar

Due to severe degradation of the existing un-reinforced sea wall units by the action of salt crystallisation on the surface, all units were replaced. As part of the reconstruction the units were precast and then set in position. With a wave return section, these complicated elements were cast using steel moulds. To improve their predicted life it was decided by the engineers to use Zemdrain® MD to cast all exposed surfaces. The liner was easily fitted to the steel forms and the resulting units are an excellent example of the benefits of using a CPF liner. Similar units have been cast worldwide and the new Zemdrain® MD selfadhesive makes lining this type of unit even easier.



Container Terminal, Freeport, Bahamas

Freeport Container Port on Grand Bahama has undergone several redevelopments over the years. To ensure compliance with the 50-year design life requirement of the Client the concrete specification for the new deep water quay took account of the harsh marine environment and was designed to a severity rating of 4 in accordance with PIANC recommendations. In addition, the use of a controlled permeability (CPF) liner was specified to all in-situ concrete shuttered faces and Zemdrain® MD was used.



Use of Zemdrain® for Dams, Locks and Power Stations

Concrete structures designed to comply with a long design life requirement must be built with materials which satisfy this demand.

Zemdrain® use helps to preserve structural integrity and life by:

- The virtual elimination of all blowholes and pinholes; increased surface strength helps resist the erosive action of the water;
- Reduced porosity increases the resistance to chloride ingress;
- Reducing potential growth of micro organisms and mussels due to release agents not being used.

Many dams and associated spillways now have to be renewed because insufficient attention was paid in the past to the concrete surface quality.

Zemdrain® use in the refurbishment process ensures that the repaired structures will have the maximum possible life.

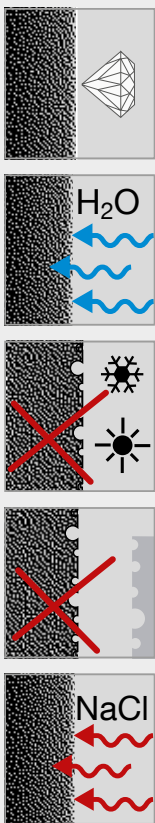

Refer to page 11.

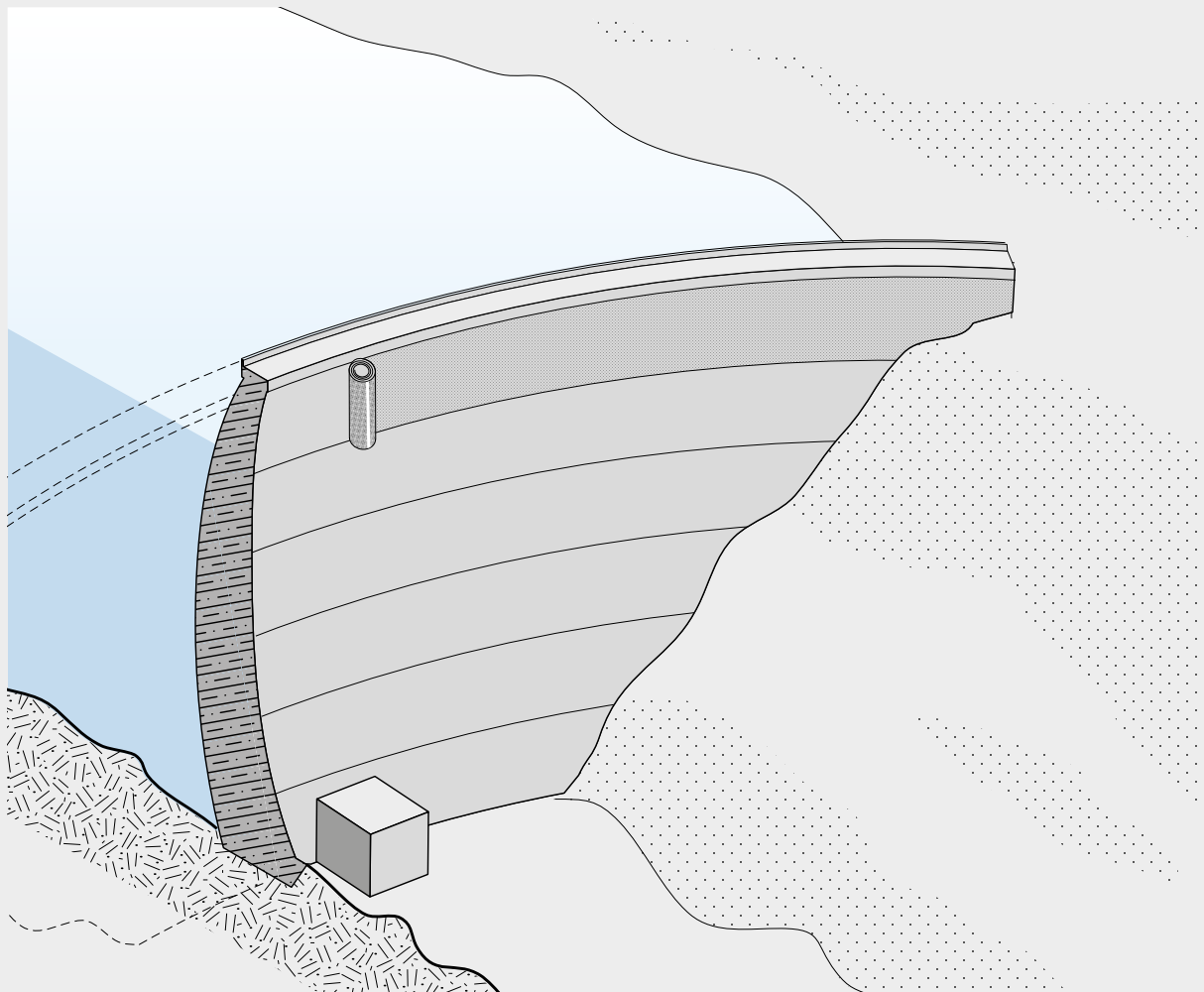

Hydroelectric Power Station Burejsk, Russia

The Bureja lock is located in Eastern Russia in the Oblast Amur and Chabarowsk regions and it is approximately 140m high and approximately 810m long. 6 turbines generate 2000MW electrical current out of the dammed-up Bureja river. In view of the extreme temperature differences between summer and winter and the expected concrete erosion by frost and water, Zemdrain® MD was successfully used for reconstruction of the spillway and discharge of the hydroelectric power station.



Pollan dam, Bundoran, Co. Donegal, Ireland

This composite concrete gravity and rockfill embankment dam is situated on the River Crana in a remote upland area of Co. Donegal. The central 130m long concrete dam was formed from 18 blocks comprising abutment, buttress and spillway sections. All blocks have an outer skin of facing concrete of a higher grade than the hearting concrete and Zemdrain® Classic was used on all faces exposed to the aggressive reservoir water to improve concrete durability. The uncontrolled spillway was arranged to form part of the dam. This stepped ogee type spillway incorporated a sloped stilling apron with chute and baffle blocks to dissipate energy and control the hydraulic pump.



Refurbishment of lock Muldenberg, Germany

The Muldenberg lock is located in the Vogtlandkreis of the German federal state of Sachsen. It ensures potable water supply of 100.000 inhabitants in 21 villages and at the same time protects against inundation. The retaining wall of the Muldenberg lock is a bent gravity dam made of unshaped stone according to the Intze principle. The lock was refurbished from 2001 to 2007 and was put into operation again in June 2009. The crest of the lock serves as cycle and walking track. Zemdrain® was used both for the retaining wall and for the crest.



Use of Zemdrain® for Transport Infrastructure

In northern climates it is the effects of de-icing salts and freeze/thaw action, whilst in coastal regions and in warmer climates it is the chloride salts in the air that cause premature concrete degradation. Repairing transport structures whilst maintaining traffic flow will always be difficult and expensive, so it is better to get durability right at the time of construction using Zemdrain®.

- The concrete cast using Zemdrain® gives excellent resistance to freeze/thaw cycling damage
- The concrete cast using Zemdrain® gives excellent resistance to the actions of salt spray (e.g. for bridges, parking decks, underground car parks, tunnels).

Tests on a bridge structure after over 7 years in service have shown that the durability improvements measured at the construction phase have been maintained in-service.

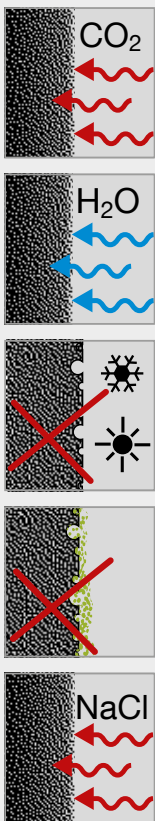

Refer to page 11.

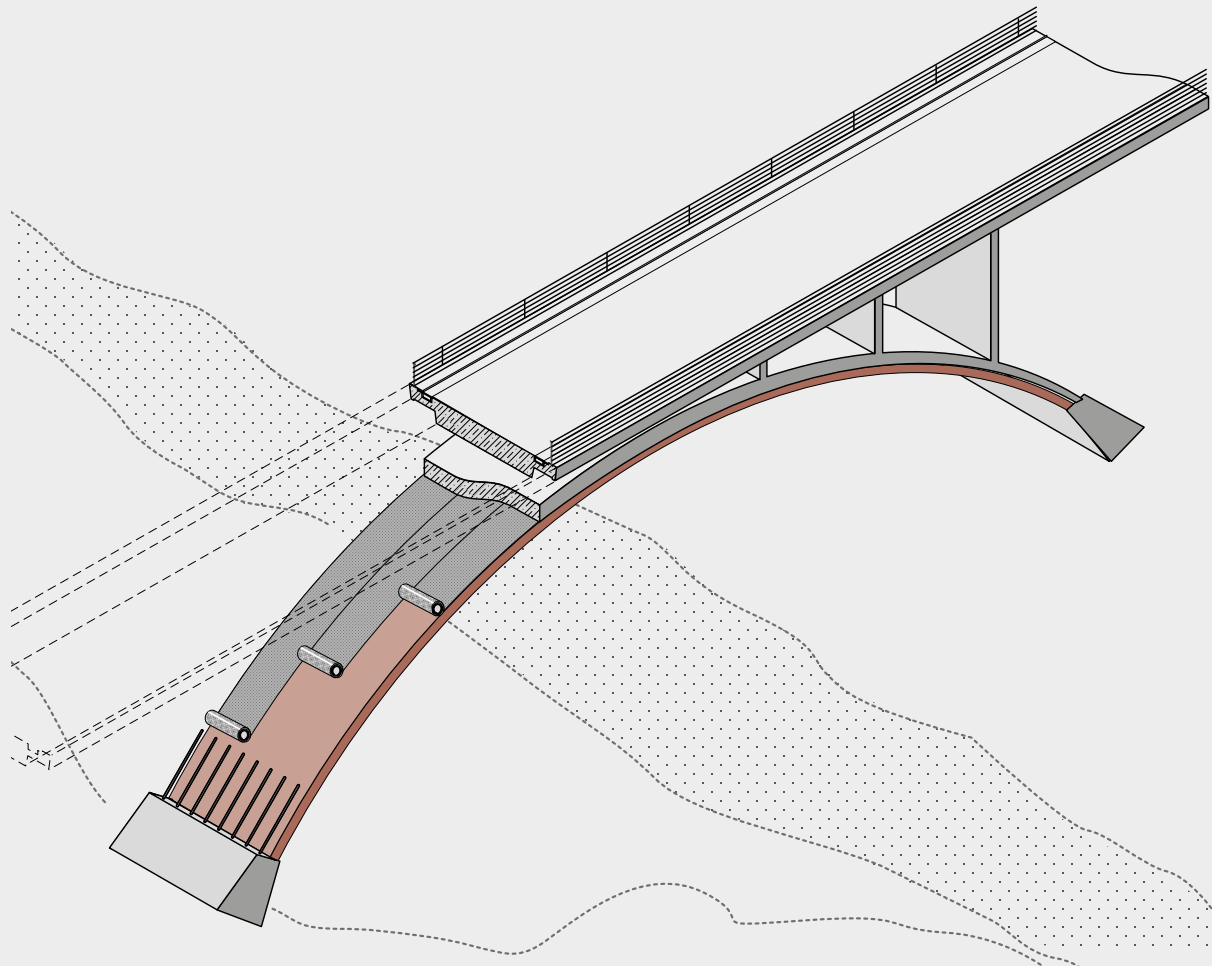

Al Garhoud Bridge, Dubai, U.A.E.

Major considerations for any concrete structure in the Gulf region are durability and whole life costs due to the extremely hostile environment. High salt contents combined with high humidity and frequent sand storms provide a severe test of any concrete which is also exacerbated for structures over water. To ensure the highest quality concrete surfaces and maximum durability resistance the use of Zemdrain® was specified by the project consultants for the most critical areas of the bridge.



Finnetunnel/West Portal, Erfurt-Leipzig/Halle, Germany

With a scheduled length of 6970m the Finnetunnel will be the longest railway tunnel of the new railway line Erfurt-Leipzig/Halle. The project comprises two parallel single-track tunnel tubes arranged at an average centre distance of approximately 25m.

A roadway forms the tunnel superstructure. In May 2008, works on the West Portal of the Finnetunnels started. To satisfy the requirement of exposed concrete class SB3, the surface had to be smooth and free from blowholes. This goal was achieved by using Zemdrain® MD very successfully.



Flintshire Bridge, Connah's Quay, Wales, UK

The Flintshire bridge is a reinforced and prestressed concrete cable-stayed structure. The 118m high "A" frame support tower was constructed from pre-cast shell elements in white concrete with subsequent infilling with grey concrete after erection. In view of the aggressive marine environment, these units were cast on site in purpose made forms lined with Zemdrain® Classic to produce a dense surface finish.

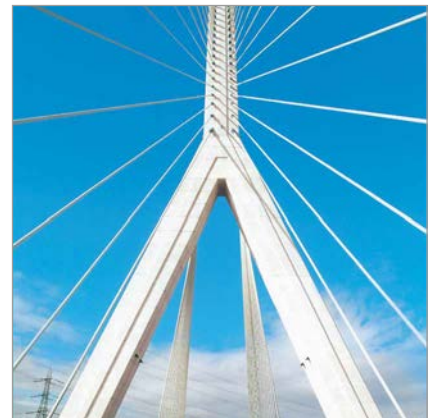

Use of Zemdrain® for Exposed Concrete

Zemdrain® creates a characteristic concrete surface. This blowhole free, matt, slightly textured and darker exposed concrete features a more intensive colour effect than common concrete surfaces.

Zemdrain® use creates façades which are more resistant against most environmental influences. The requirement for a homogeneous quality, however, can only be satisfied by careful planning, execution, production of a sample surface and following guidelines and consulting provided by the company Max Frank. Deformations of the formliner caused by any potential temperature variations can be reduced using a special technology.

Zemdrain® use gives a surface that has:

- An even matt texture that intensifies the colour of the cement;
- Virtually no blowholes or pinholes
- Increased resistance to all forms of weathering; therefore a much longer service life of the untreated surface;
- Much reduced growth of algae;
- Very good resistance to graffiti;
- No release agent residues.

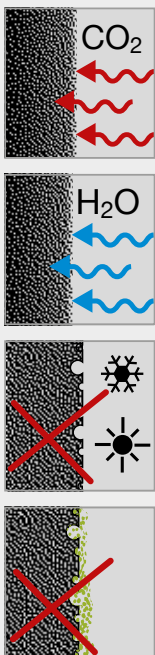

Refer to page 11.

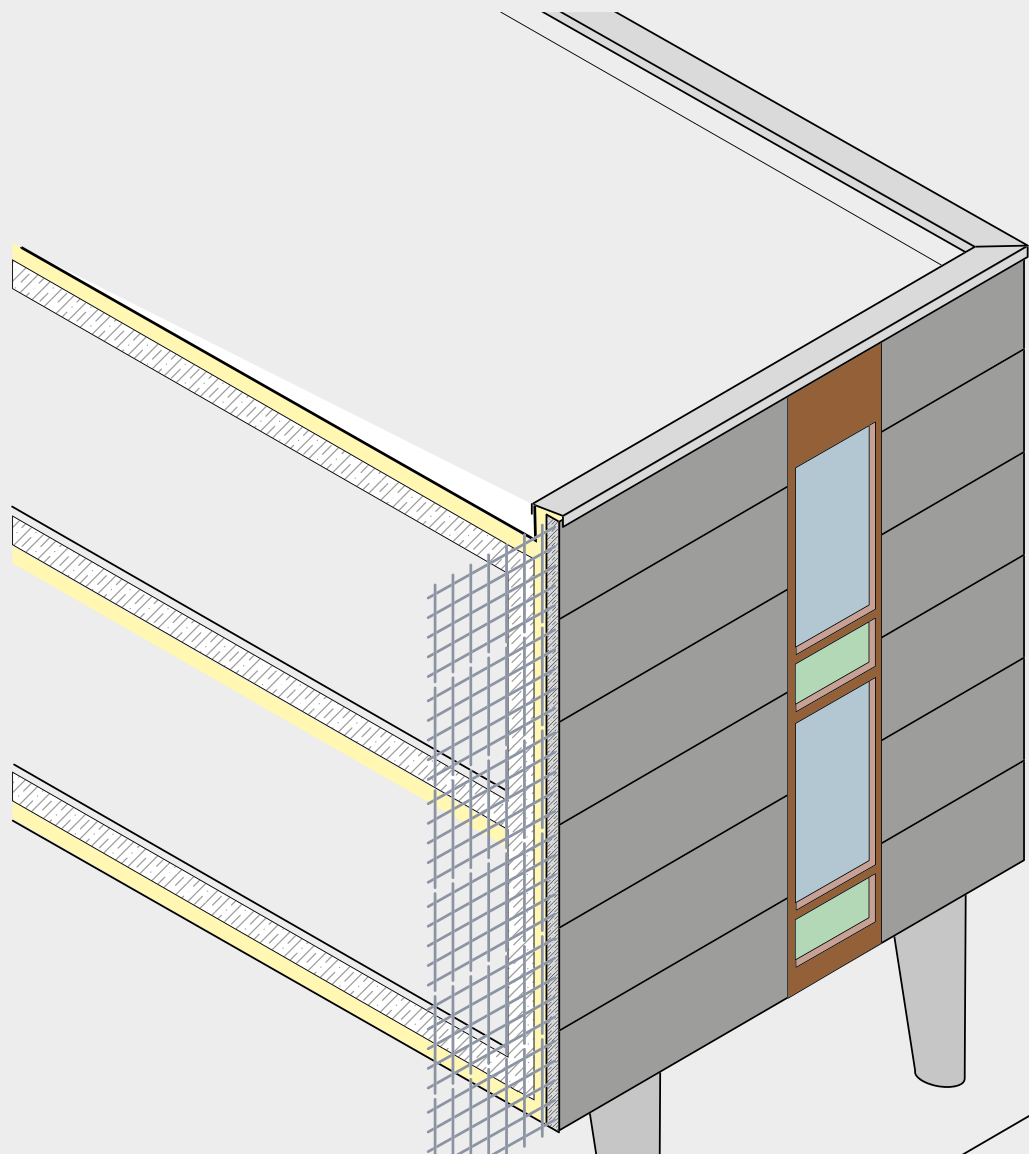

Exposed Concrete Façade of a school in Langenau, Germany

At the occasion of the refurbishment and erection of an annex building to the school at Langenau, the building's façades were made of prefabricated concrete elements.

Clients requested a slightly darker, more intensive tone for the exposed concrete façades, which was achieved by using concrete with black colouring pigments. In order to intensify the colour intensity and to avoid bright reflexes, Zemdrain® Classic was used for the visible sides of the precast panels.

The homogeneous but slightly textured surface of the façade elements creates a characteristic optical appearance of the exposed concrete. Additionally Zemdrain® improves the water/cement ratio and durability of the façade elements against weathering and algae growth.

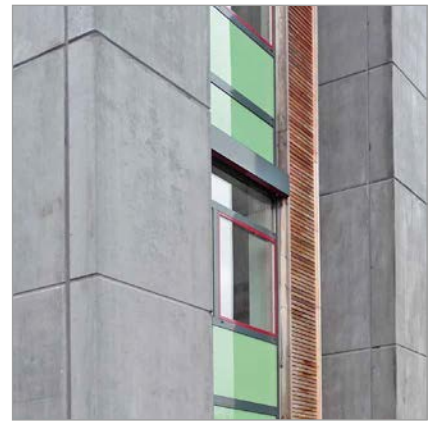

Museum Biedermann, Donaueschingen, Germany

Throughout the years 2008/2009 the museum Biedermann was refurbished and extended. The annex building was fitted with monolithic walls made of black lightweight concrete. The formwork for all exposed concrete walls was produced using Zemdrain®.

After production of sample walls with different textures the client opted for Zemdrain®, in order to obtain a homogeneous surface in spite of the difficult aeration of lightweight concrete.

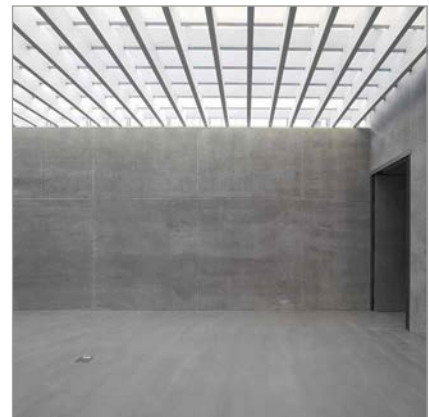

Pictures: Bernhard Strauss, Freiburg

*Flintshire Bridge,
Wales (UK)*



Conventional formwork, i.e. timber, plywood, steel and plastic faced formwork accumulate excess water

To enable correct placement all concrete requires a higher initial water/cement ratio than that required for the concrete's hydration process. The result of this will be that a concrete with a water-cement ratio of 0.45 – 0.5 will contain a water surplus of 40 – 60 litres/m³. During the placement and compaction phase, excess air and water migrate to the concrete/impermeable formwork interface increasing the water/cement ratio further in the outer cover zone.

The result:

A surface with an increased water/cement ratio which results in reduced durability and a simultaneous increase in blowholes and other surface blemishes.

Concrete damages

Damage to concrete structures is mainly caused by external environmental influences which can be accentuated by the initial poor quality of the surface. Even after relatively few years damage can be so severe that the surface concrete needs to be refurbished or replaced completely. This problem is mainly due to:

- Blowholes, pinholes and increased porosity
- Release agent residues provide a food source for the growth of microbiological organisms and increase the adhesion of
- Frost and abrasion lead to surface scaling
- Chemical attack results in corrosion of surfaces and concrete spalling
- Chlorides may directly access the reinforcement and cause corrosion
- CO₂ leads to carbonation and to the loss of alkalinity

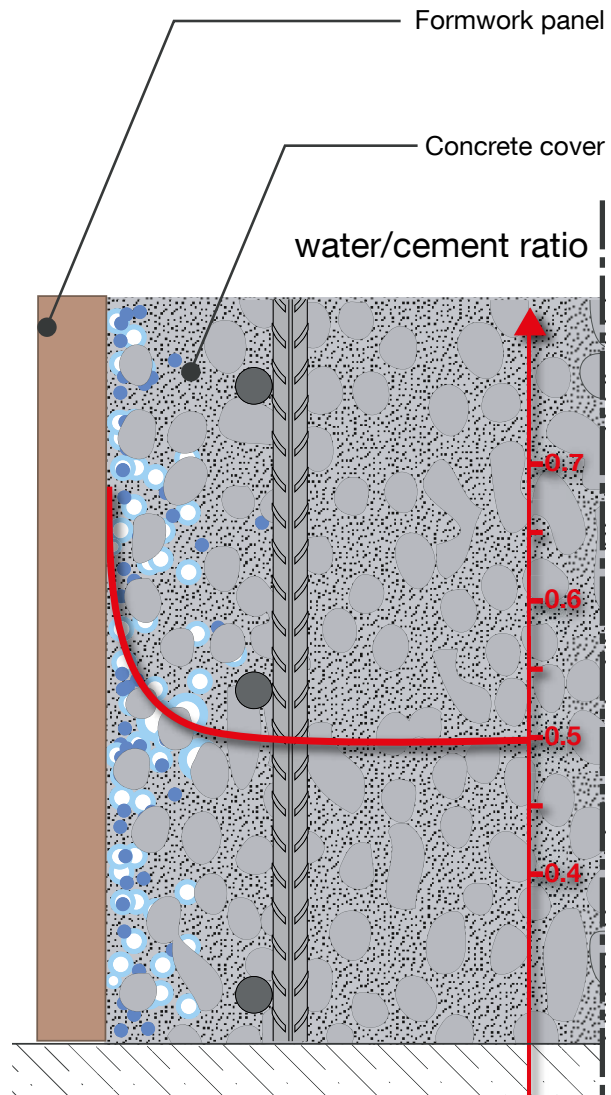

Increased water/cement ratio in the outer 20mm of the cover zone when using conventional, oiled impermeable formwork



Concrete surface degraded by wastewater



Concrete surface degraded by abrasion and microbiological growth)



Concrete surface degraded by sea water

Zemdrain® Functional principle and concrete improvement

Compaction energy and concrete pressure lead to drainage of a major part of the excess water contained in the outer 20mm of the concrete surface of up to 2.5l per m². This optimises the water/cement ratio and reduces porosity optimizing the concrete quality.

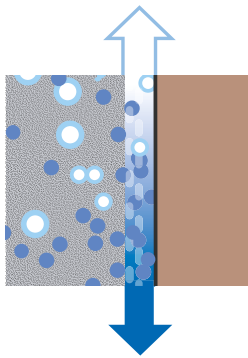

During the compaction phase, the excess air and water passes through the filter layer. The water is transported to the bottom of the form, whilst the air escapes upwards.

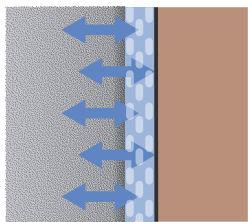

During the period between the end of compaction and the removal of the formwork, a proportion of the drained water is retained within the structure of the liner and is available for the initial curing phase. This water can be reabsorbed by the hydrating concrete and ensures high quality early age curing, which cannot be achieved by any other method.

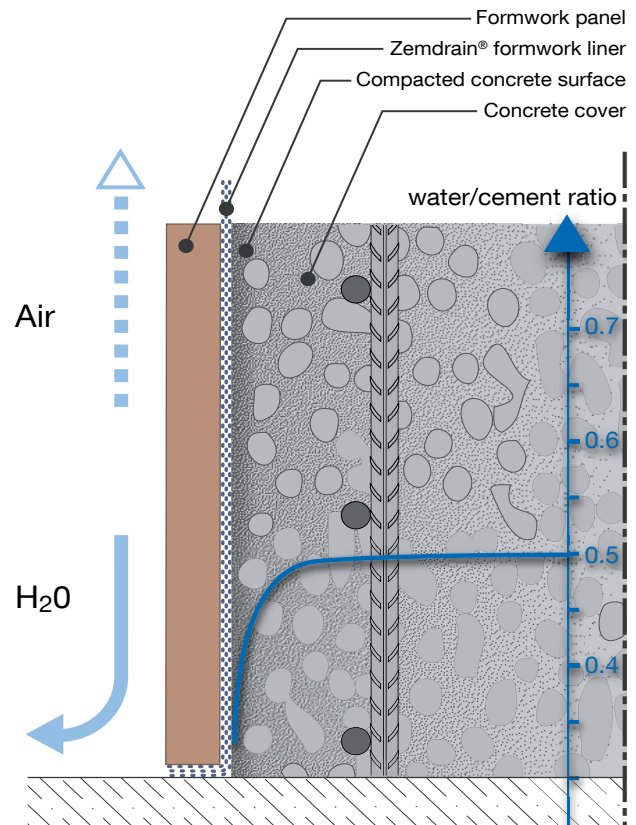

The following fundamental rule applies:

A low water/cement ratio reduces porosity and capillarity and at the same time increases density.

The following material properties are thus clearly identified:

- Water transport through capillaries is reduced to some millimetres only. Thus restricting chlorides ingress to the reinforcement.
- Reduced migration keeps certain chemical processes, such as carbonation, to a minimum.
- Avoiding the use of release agents keeps organic substances away from the surface concrete that might cause growth of micro organisms.
- The optimum water/cement ratio creates a harder surface concrete zone enormously reducing abrasion by water (hydro abrasion) or airborne particles.

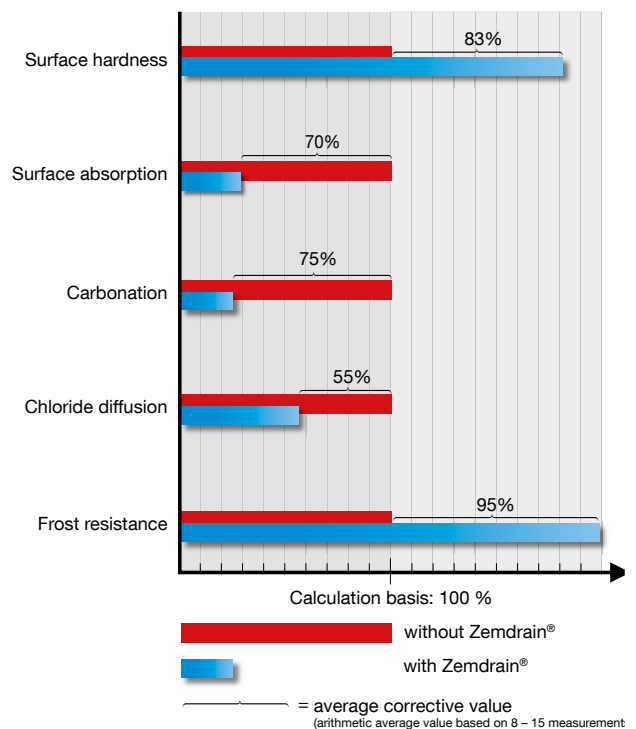

Concrete Structures for Infrastructure

Concrete in most infrastructure projects is subjected to very harsh operating conditions. Structures in contact with sea water or in coastal zones, as well as bridges in cold climates can all be subjected to extreme environmental attacks from chloride salts. For water related projects attack from acids, chemicals, soft water, etc are also a major problem. Asset owners increasingly demand that their calculated lifetime must be met and even increased to about 100 years. For safety and economic reasons and aesthetic

aspects, major refurbishments within this time period are not recommended. It is important to maximize the maintenance free life of all structures by getting things right at the construction phase. According to the tests on existing structures and results from laboratory tests, the use of Zemdrain® considerably increases the potential service life of the surface concrete zone. The result can be that premature refurbishment or indeed complete rebuild can be avoided.

Chloride migration coefficient

The result of the tests on the chloride migration coefficient with time factor means that at a difference of 5×10^{-12} , protection time of the reinforcement against corrosion is extended by approximately 50 years.

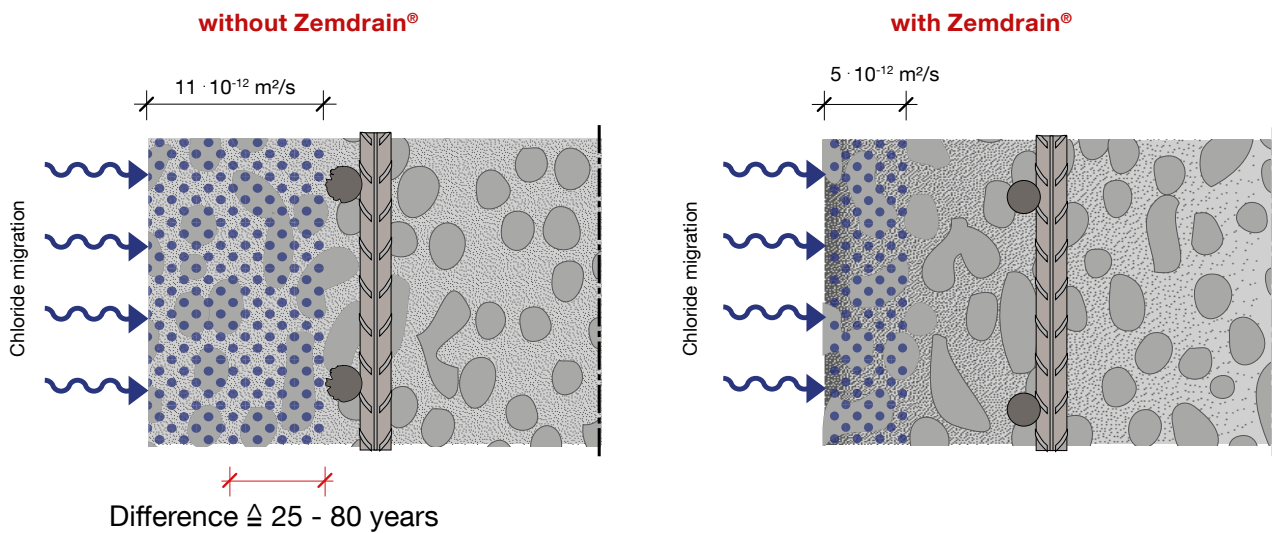

Tests on a concrete wall exposed to sea water show significant improvements to the rate of chloride ingress.

	Surface cast with oiled steel formwork after 3 years exposure		Zemdrain® cast surfaces after 6 years exposure	
	Tidal zone	Splash zone	Tidal zone	Splash zone
Surface hardness	42.0	41.6	52.0	55.3
Surface tensile strengths [N/mm ²]	0.8	1.0	2.4	2.2
Porosity [%]	4.665	5.958	3.203	3.391
Surface absorption [m ² /sec. x 10 ⁻¹²]	46.1	36.4	16.1	11.4
Chloride content at surface [% weight in relation to cement]	7.7	10.4	2.3	3.3
Chloride migration coefficient [m ² /sec. x 10 ⁻¹²]	12.0	27.9	8.1	9.2

Concrete Structures in Wastewater Treatment Plants

Concrete structures in wastewater treatment plants are exposed to various forms of attack:

- Atmospheric influence
- Freeze and thaw
- Hydro abrasion
- Acid/Chemical attack by wastewater and air

With a usual design life of 50 years, concrete structures in wastewater treatment plants must not only fulfil specifications with regard to load-bearing capacity and fitness for use, but also with regard to durability.

Studies to improve concrete quality and durability over the last 20 years have led to the development of new improved concretes. Despite these improvements significant damage to concrete surfaces in wastewater treatment plants continues to occur. These surfaces have needed to be refurbished several times at high costs.

Only the use of Zemdrain® improves the surface concrete quality in a way to ensure that it permanently resists these attacks. Numerous long-term observations and tests carried out in two wastewater treatment plants after 10 years of operation give evidence thereof.

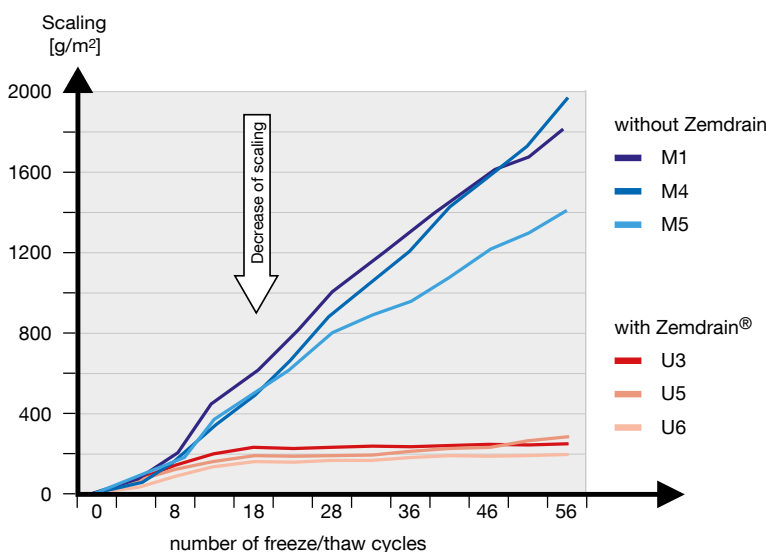

Result of scaling in g/m² after 56 frost/thaw cycles (refer to analysis of FEhS 2008/310)

Summary of long-term performance:

For the “Experts report of highly stressed reinforced concrete structures from wastewater treatment plants” (Institute for Research on Construction Materials FEhS 2008), concrete cores were extracted from the test structures and the results are summarized as follows:

- Visible difference between structural elements made with and without Zemdrain® (refer to picture 1)
- Tensile strength of concrete surfaces produced with Zemdrain® is increased by 30%
- After 56 freeze/thaw cycles, scaling of concrete surfaces produced with Zemdrain® was 7.5 times less than the control surfaces (refer to picture 2)

In view of the fact that even artificial ageing did not have any influence on the structural elements produced with Zemdrain®, evidence is produced that use of the permeability formwork liner considerably extends lifetime of the concrete walls despite their exposure to wastewater.



Picture 1: Visual difference between concrete walls produced with Zemdrain® and without Zemdrain® at the walls of the wastewater treatment plant Offenburg after 10 years of operation.



Picture 2: Difference between concrete cores (left side with Zemdrain®, right side without Zemdrain®), after 56 freeze/thaw cycles.

Concrete Structures in Drinking Water Reservoirs

Concrete reservoirs generally comply with EU guidelines or EFTA regulations. Inside lining of drinking water reservoirs must, however, comply with strict regulations.

- Nearly free from pores and blowholes
- No release agents to be used
- High resistance against hydrolysis
- Hygienic uncontaminated surface
- Surfaces which may be cleaned easily
- Lifetime of more than 50 years

Drinking water reservoirs are normally designed and built for a lifetime of at least 50 years. Latest studies prove that concrete surfaces cast with Zemdrain® remain in perfect condition during this time period. Walls and roof soffits of newly erected drinking water reservoirs should therefore be cast with the permeability formwork liner as recommended by the DVGW.

For further details on the benefits of Zemdrain® used in drinking water reservoirs, kindly refer to the report “Drinking water reservoir produced with controlled permeability formwork liner: Analysis of the water chamber after 15 years of operation (Dr.-Ing. Merkl 2006)”.



High-porosity concrete surfaces in drinking water reservoirs show a risk of hydrolysis. Use of Zemdrain® reduces the porosity in relation to the concrete core, whereas porosity increases without Zemdrain®. This maintains the concrete's alkalinity over a long period of time. These surfaces protect the drinking water against micro organic growth.

Test result after core drilling in three different water reservoirs – surface concrete with Zemdrain®

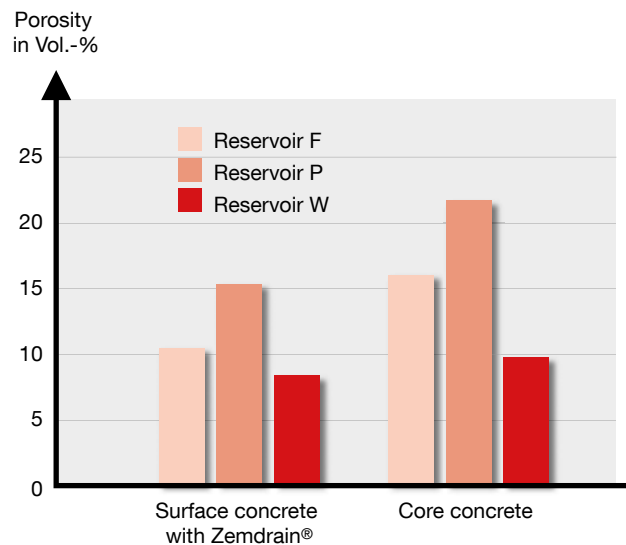

Dr. Ing. Merkl, Test Report (2006)

Conclusion of the test report summary, regarding Zemdrain® performance:

- Tests performed at three different drinking water reservoirs.
- All are in perfect hygienic condition.
- All show a low porosity in the surface concrete zone.
- All have a high compressive strength.
- None show any visible modifications caused by hydrolysis or carbonation.
- All will therefore remain in operation throughout the next decades without any specific refurbishment costs.

Test Reports





YPROS17012	Test on effectiveness of Zemdrain® formwork liner Certificate issued by the Institute for Solid Structures and Construction Technologies – Material Testing Institute at Karlsruhe
YPROS17013	Test on behaviour in contact with drinking water (Zemdrain®) Hygienic Institute of Gelsenkirchen, Germany – certificate according to the recommendation of the Drinking Water Commission, of the task force “Drinking Water Concerns”, belonging to the committee for plastic materials of the Federal Health Agency
YPROS17004	Test on growth of micro organisms for materials in drinking water applications Hygienic Institute of Gelsenkirchen, Germany – test certificate according to DVGW-W 270
YPROS17018	Reusability of “Zemdrain® MD” formwork liner Technical University of Munich
YPROS17008	Profitability analysis of the application of water-repellent Zemdrain® formwork liner ISAH Institute for Water Management and Waste Engineering at the University of Hanover, Germany
YPROS17073	Experts report on reinforced concrete surfaces cast using “Zemdrain®” formwork liners in wastewater treatment plants FEhS – Institute for Research on Construction Materials e.V., Duisburg
YPROS17007	Zemdrain® has been tested by various domestic and foreign test institutes. Kindly ask for the separate list of test reports.

Inspection Reports

YPROS17068	Special publication: Drinking water reservoirs produced with controlled permeability formliner (CPF) – inspection of water chambers after 15 years of operation PD Dr.-Ing. Gerhard Merkl
405BR05/01	Special publication: Technological assessment of the durability of reinforced concrete surfaces in wastewater treatment plants after 10 years of operation Dipl.-Ing. K. Lehmann, FEhS – Institute for Research on Construction Materials e.V., Duisburg

The above-mentioned test reports and inspection reports are published on our website www.maxfrank.com and are available for download.

Tools for working with Zemdrain®

	Designation	Art. no.
	<p>Tensioning clamp, wide-area clamping and tensioning of Zemdrain® Classic across smaller formwork areas. Fix subsequently using staples.</p>	<p>ZSZKAZ</p>
	<p>Tensioning clamp MD 2.5 m, two-piece tensioning clamp for Zemdrain® MD</p>	<p>ZSZMD2500</p>
	<p>Tensioning belt 35 mm x 2,5 m, for tensioning Zemdrain® Classic prefabricated.</p>	<p>ZRSPANN</p>
	<p>Tensioning device for fixing of Zemdrain®</p>	<p>ZSL0810</p>
	<p>Ceiling tendon</p>	<p>ZDSV</p>



Max Frank GmbH & Co. KG

Mitterweg 1
94339 Leiblfling
Germany

Tel. +49 9427 189-0
Fax +49 9427 1588

info@maxfrank.com
www.maxfrank.com